

Nikon

AUTO REFRACTOKERATOMETER

Speedy-K

Instructions

Thank you for purchasing this Nikon product.
 This instruction manual is written for users of the Nikon "Auto Refractometer Speedy-K."
 To ensure correct usage read this manual carefully before operating the instrument.

- It is prohibited to alter this manual in part or whole without expressed permission.
- The contents of this manual are subject to change without any notice.
- Although every effort has been made to ensure the accuracy of this manual, if you note any points that are unclear or incorrect, contact your nearest Nikon representative.
- Note that despite the above, Nikon does not bear any responsibility for any claim over loss due to the use of this instrument.







Caution Symbol in This Manual

Though Nikon products are designed to provide you utmost safety during use, incorrect usage or disregard of the instructions can cause personal injury or property damage. For your safety, read the instruction manual carefully and thoroughly before usage. Do not discard this manual but keep it near the product for easy reference.

Inside this instruction manual, safety instructions are indicated with the symbol shown below. Be sure to follow the instructions marked with this symbol for your safety.

Symbol	Meaning
 CAUTION	Disregarding instructions marked with this symbol may lead to injury or property damage.

Meaning of Symbol on the Instrument's Cover and Nameplate

	AC power		OFF (cut off from power supply)
	Fuse		ON (connected to power supply)
	Caution: Please refer to instruction manual.		Input and Output
	Class B device		

Please Read This First for Your Safety.



CAUTION 1 Intended Use

Only use the Auto Refractometer Speedy-K for measuring the refractive power of the eye and curvature of the cornea.

Do not use this instrument for any other purpose.



CAUTION 2 Do Not Disassemble

Disassembling this instrument may lead to electric shock and/or malfunction of the instrument. Never disassemble this instrument.



CAUTION 3 During Measurement Operations

- Particularly in the case of little children, take care that patients do not put their fingers in the moving parts of this instrument.

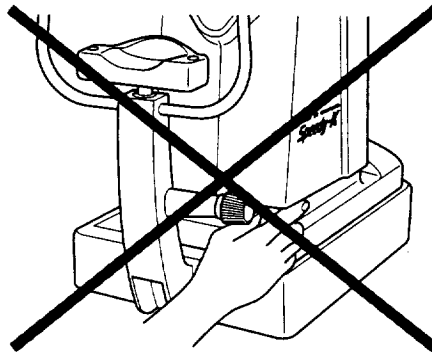

- Take care that the measuring head does not strike the patient's nose. (When moving the measuring head toward the patient or toward the patient's left or right eye.)

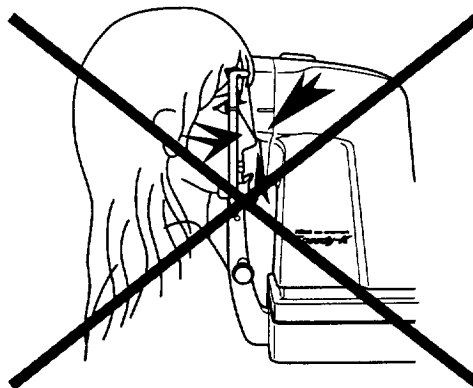



CAUTION

4

During Installation and Transportation

Be absolutely sure to support the instrument as shown in the figure at left during transportation. Do not carry the instrument by the forehead rest, measuring head or joystick lever.

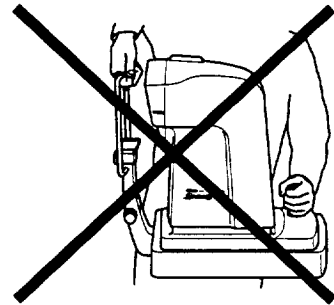
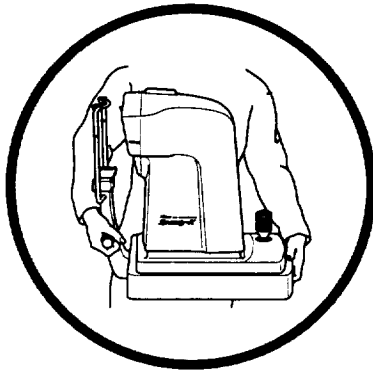

- Recommended operational conditions are an air pressure of 800 to 1060 hPa, a temperature of approximately 10°C to 35°C, and a relative humidity of 30 to 70%.
- Although the instrument is dust-proof, do not use it in a room where there is a lot of dust or dirt.
- The best place for installation is a dimly lit room. Do not face the patient side of the instrument toward a bright window or source of light.
- Although this instrument conforms to EMC standards (IEC60601-1-2:1993), it does emit a weak electromagnetic signal. If use of this instrument affects other equipment such as televisions or radios, separate it from the affected devices or change the direction it faces.
- When transporting this instrument, always be sure to first tighten its securing screws. (→ P.8)
- Since this instrument is not water-proof in construction, never take it into locations where liquids such as rain or beverages may get inside.
- If condensation (dew) forms, do not use the instrument until the condensation disappears.



CAUTION

5

Other Notes on Handling

- Do not scratch, break or alter the power cord or overly bend, pull, twist or bundle it. Also, placing heavy objects on the power cord or subjecting it to heat may cause it to break, resulting in fire or electric shock. If the power cord becomes damaged, be sure to replace it with a new cord.
- If there is any dust on the power plug blades or the surface they connect to, pull out the power plug and remove the dust. The dust or grime can make the power plug and AC power outlet to be out of contact and may result in fire.
- This refractometer is a precision optical instrument containing many electronic components. Be sure to handle it carefully and do not subject it to strong physical shock.



Contents



■ Caution Symbol Used in this Manual	1
■ Symbols on the Instrument's Cover and Nameplate	1
■ Please Read This First For Your Safety	2
■ Equipment Supplied	4
1 Nomenclature	6
2 Preparation	8
2-1 Setting Up the Speedy-K	8
2-2 Measuring the Model Eye	10
2-3 Checking Settings	11
3 Measurement Method	12
■ Measurement Screen	12
■ Description of Test to Patient Before Measuring	13
■ Measurement Modes and R-K Modes of the Unit	13
3-1 Auto Measurement Mode	15
3-2 Continuous Measurement Mode	18
3-3 Manual Measurement Mode	19
3-4 Quick Measurement Mode	20
3-5 Printing	21
3-6 Miscellaneous	24
Automatic Fogging / IOL Patients / When Keratometry Measurement is Impssible /	
Measuring a Hard Contact Lens Base Curve / Error Messages / Representative Values for	
Refraction and Keratometry Measurements / Refraction Confidence Values / Storing	
Measured Values / Automatic Power Conservation	
4 Retro Mode	28
5 Making Various Settings (Setup)	29
6 Connecting to External Devices	43
? Maintenance	44
7-1 Checking Measurement Accuracy	44
7-2 Replacing a Printer Paper Roll	44
7-3 Changing the Fuses	45
7-4 Cleaning the Chin and Forehead Rests	46
7-5 Cleaning the Measurement Window	46
7-6 Cleaning the Model Eye	46
7-7 Cleaning the Painted Components	46
8 Troubleshooting	47
9 Specifications	48



Nomenclature

Infrared signal generator

Sends a signal to an Auto Optester "Remote Vision".

TV monitor

Enables the operator to take measurements while monitoring the patient's eye on the TV monitor. Measurement data is also displayed on the monitor.

FUNCTION keys

Press to enter various setup modes and retro mode.

SET key

Press to enter a given setup screen.

POWER lamp

Lights when the power switch is set to ON.

PRINT key

Press to print out data. Printouts are made automatically in auto measurement mode. (→ P.21)

Measurement switch

Press to start measurements. It is not necessary to press this switch in auto measurement mode or continuous measurement mode.

Joystick lever

Used for right/left and forward/backward positioning during measurement.

Printer cover

Open in the following cases:

- To change the printer paper roll
- To adjust the TV monitor's brightness or contrast.

Measuring head

Houses the measuring mechanism.

Transport securing screw hole

A securing screw can be tightened to protect equipment from vibration and shock during transport. Remove this screw after installing this instrument and store it in the storage compartment (2). Re-tighten the screw whenever moving the equipment. (→ P.8)
The handy clamp screw is screwed into this screw hole. (→ P.9)

Fuse holder

Contains the fuse. (→ P.45)

RS-232C interface connector

Used when connecting to external devices. (→ P.43)

Input power cord

Connect to an AC power outlet.

Input power cord socket

Plug the power cord into this socket.

Power switch

Power is ON when "|" side is pressed and OFF when "○" side is pressed.

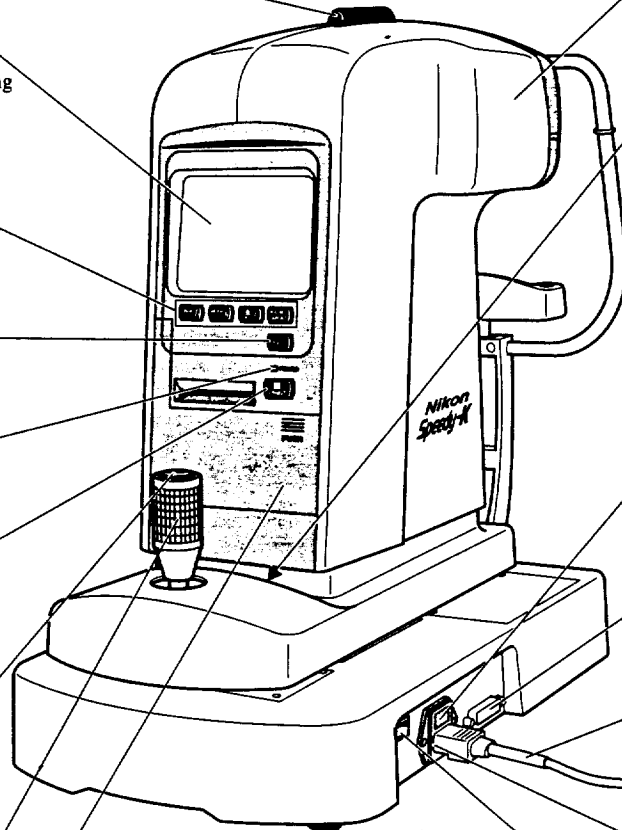



1. Nomenclature

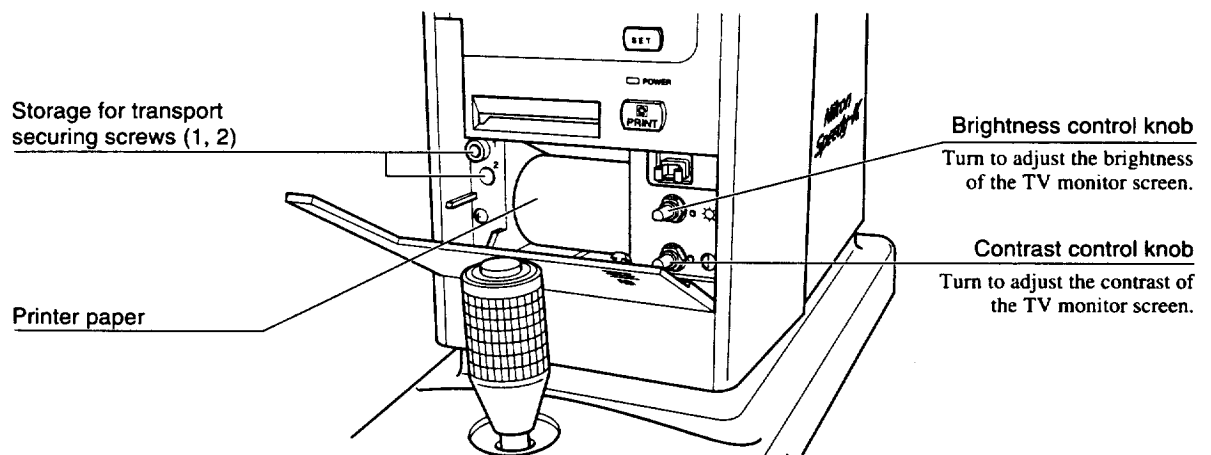
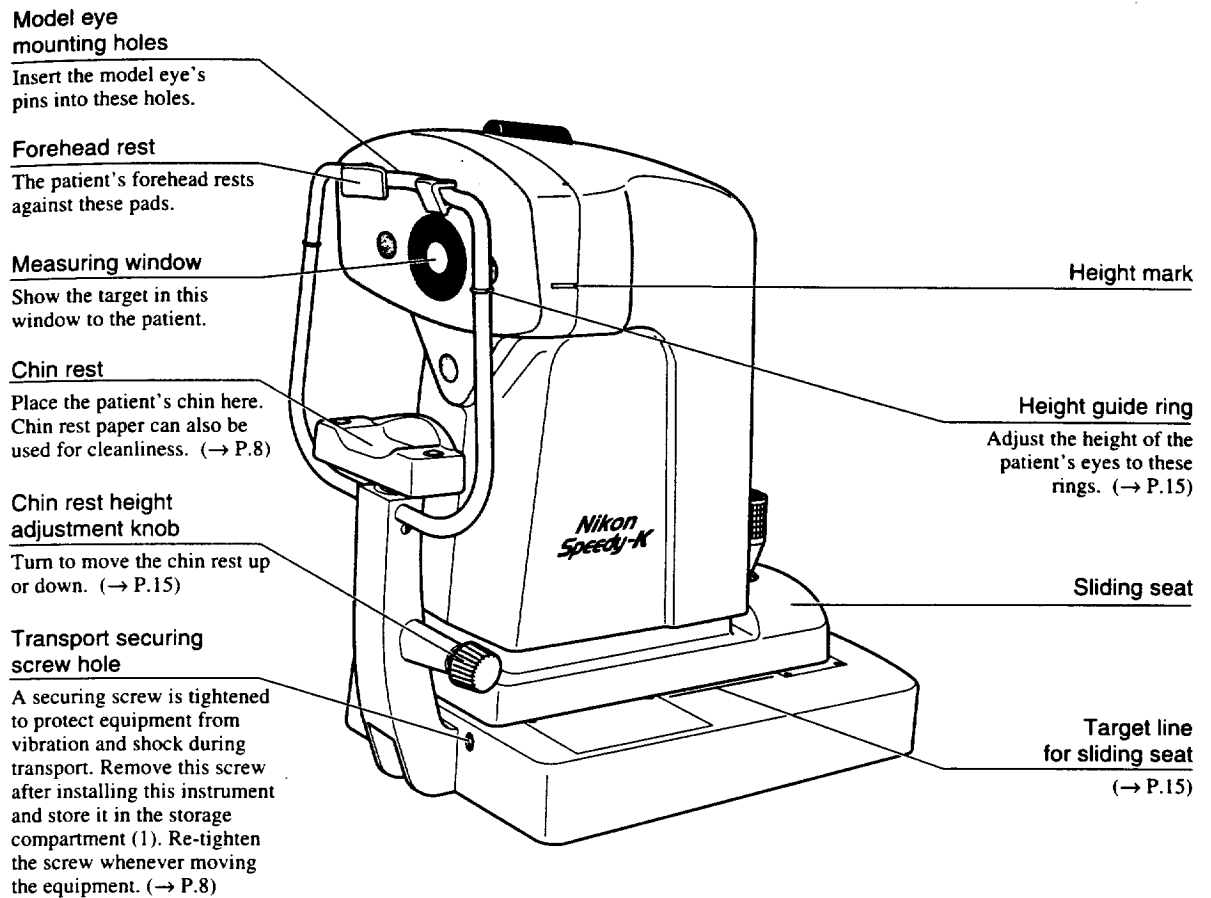

(When the printer's cover is opened)

2

Preparation

2 - 1 Setting Up the Speedy-K

- 1 Place the unit on a stable table (such as a power table).
- 2 Remove the two transport securing screws using the Philips screwdriver.
Cover the screw holes with the caps provided.
Store the two securing screws in the storage compartment to the left of the printer. (→ P.7)
Always be sure to tighten the securing screws when transporting the unit.

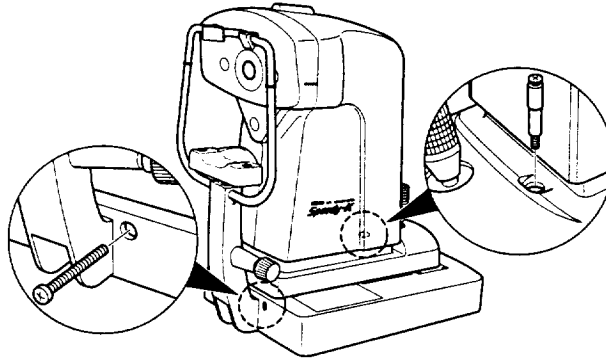

- 3 Plug the input power cord into the unit's input power cord socket.
- 4 Plug the other end of the input power cord into an AC power outlet.
- 5 Turn the unit's power switch ON. The POWER lamp will light, the TV monitor screen will brighten, and the unit can now make measurements.
- 6 Insert a printer paper roll. (→ P.44)
- 7 Clean the forehead rests and chin rest with disinfectant alcohol.
When using chin rest paper (sold separately), pull up the two chin rest pins and hook the chin rest paper between them. Use of a thickness of about 5 mm of chin rest paper is appropriate.

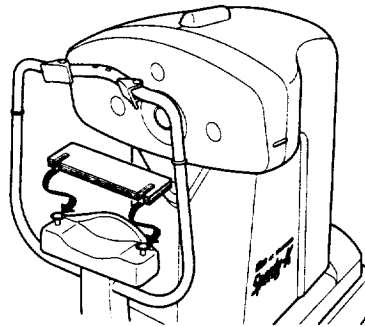



■ **Using the handy clamp screw**

When setting the instrument on the adjustable table (such as the double table), clamp the right, left, fore and backward movement of the sliding seat by screwing in the handy clamp screw.

Remove the provided cap of the transport securing screw hole from the instrument. Screw in the handy clamp screw holding the knurled part, till the screw cannot be turned further.

To clamp the right, left, fore and backward movement:

Push in the top of the screw and turn right.

To release the clamp:

Turn left till the top of the screw pops up.

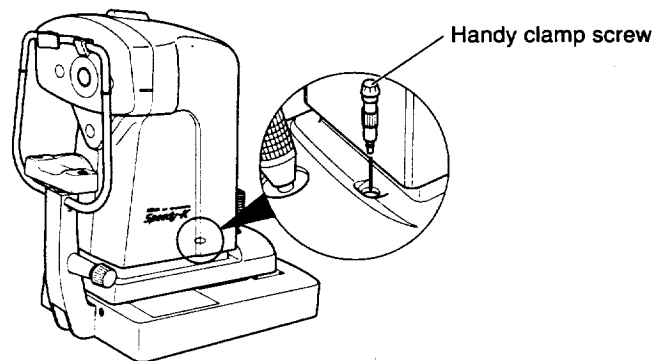

2 - 2 Measuring the Model Eye

1 Insert the model eye's two pins into the model eye mounting holes in the forehead rest part.

2 Check the VD value on the TV monitor.
(120V: 13.75, 230V: 12.0)

3 Using the joystick lever, align the target with the model eye.
(For details on the measurement method, refer to P.12 to 27.)

4 Compare the measured values for the model eye with the values (SPH, CYL and R) listed on the label attached to the model eye and check that the difference in values all fall within the following corresponding ranges.

SPH : $\pm 0.25D$	CYL : $\pm 0.25D$
R1 : $\pm 0.02mm$	R2 : $\pm 0.02mm$
T : $\pm 0.05mm$	N : $\pm 0.05mm$
S : $\pm 0.05mm$	I : $\pm 0.05mm$

If either value is not within the above range, refer to "3 Measurement Method" (P.12 to 27) and check that the measurement method is correct and then re-measure.

Next, refer to "7-5 Cleaning the Measurement Window" and "7-6 Cleaning the Model Eye" (P.46) under "7 Maintenance" and clean these parts if they are dirty. If either value still is not within the above range, please contact your nearest Nikon representative.

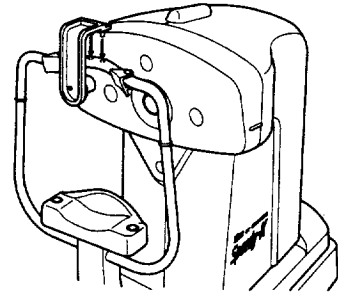



2 - 3 Checking Settings

Factory settings are as follows.

For details on the meaning of settings or on how to change settings, refer to "5 Making Various Settings (Setup)" (P.29 to 42).

Measurement mode setting	AUTO
Fixation chart brightness setting	H
Patient No. setting	00001
PRINT setting: AUTO PRINT	ON
PRINT setting: REF PRINT	ALL
PRINT setting: KERATO PRINT	REP
PRINT setting: MESSAGE	OFF
R-K ORDER setting	120V: RK, R, K, RKP, KP KEEP ON 230V: RK, RKP, R, K, KP KEEP ON
REF setting: CYL (astigmatism sign)	- (Minus)
REF setting: STEP (minimum unit)	AUTO
REF setting: FRAME VD	120V: 13.75 230V: 12.00
KER setting: mm/D (unit of measure)	mm
KER setting: INDEX	1.3375
KER setting: KERATO TRANS (transmission setting)	OFF
Buzzer setting	ON
Date display format	120V: MDY 230V: DMY
Time display format	120V: AM/PM 230V: 24H
Print message	Blank
RV IR ID setting	OFF
RS-232C setting	OFF
Word setting	EG

■ Description of Test to Patient Before Measuring

Most patients will be rather nervous, so try to put them at ease. Briefly explain the unit's operation and purpose to the patient.

- "This machine determines the power of the spectacle lenses you should use."
- "You will see a green field inside. Please relax and look at the tree target in the center."
- "Try to keep your eye as still as possible."

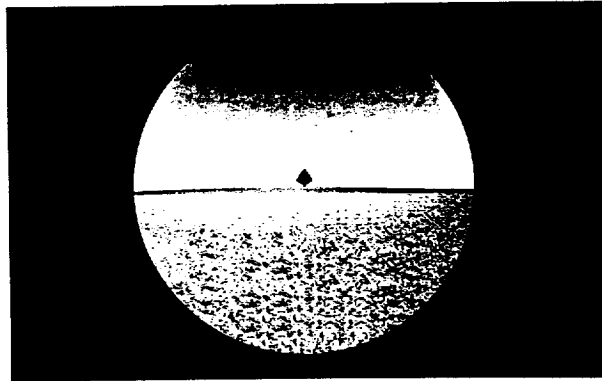

■ Measurement Modes and R-K Modes of the Unit

This unit possesses four measurement modes and five R-K modes.

Select the measurement mode and R-K mode according to the description given in "5-1. Measurement Mode Screens" (→ P.30) under "5. Making Various Settings (Setup)".

The table on the next page gives the operation performed when each mode is selected.

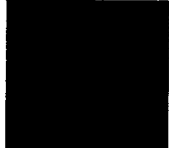

Measurement Mode \ R-K Mode	RK Mode	R Mode	K Mode	KP Mode	RKP Mode
Auto measurement mode (→ P.15) Measurements are made automatically with the unit determining all operations from the beginning to the end. When the light spot enters the alignment mark, the measurement starts. The unit determines the cause of fluctuations in the measured values and the measurement ends. If AUTO PRINT is ON, a printout is made, when measurements for the left and right eyes are completed.	Auto start ↓ Keratometry measurement (One measurement/center) ↓ Refraction measurement (5 measurements min.) ↓ Auto stop ↓ Auto print (Only when AUTO PRINT is ON)	Auto start ↓ Refraction measurement (5 measurements min.) ↓ Auto stop ↓ Auto print (Only when AUTO PRINT is ON)	Auto start ↓ Keratometry measurement (One measurement/center) ↓ Auto stop ↓ Auto print (Only when AUTO PRINT is ON)	Auto start ↓ Keratometry measurement (One measurement/center and periphery) ↓ Auto stop ↓ Auto print (Only when AUTO PRINT is ON)	Auto start ↓ Keratometry measurement (One measurement/center and periphery) ↓ Refraction measurement (5 measurements min.) ↓ Auto stop ↓ Auto print (Only when AUTO PRINT is ON)
Continuous measurement mode (→ P.18) Although measurements are started automatically in the same way as auto measurement mode, measurements do not end automatically but are made continuously. Pressing the measurement switch will stop measurement momentarily. Pressing it again will restart measurement. Press the PRINT key to print out measured data.	Auto start ↓ The following set is performed continuously: Keratometry measurement (One measurement/center) ↓ Refraction measurement (5 measurements)	Auto start ↓ Refraction measurement (Continuous measurements)	Auto start ↓ Keratometry measurement (One measurement/center)	Auto start ↓ Keratometry measurement (One measurement/center and periphery)	Auto start ↓ The following set is performed continuously: Keratometry measurement (One measurement/center and periphery) ↓ Refraction measurement (5 measurements)
Manual measurement mode (→ P.19) Measurement is not performed until the tester presses the measurement switch. When the light spot enters the alignment mark and the image comes into focus, press the measurement switch and the unit will take one measurement. Holding the switch down will continue taking measurements. Press the PRINT key to print out measured data.	Measurement switch ON ↓ Keratometry measurement (One measurement/center) ↓ Refraction measurement (One measurement) ↓ When the measurement switch is held down, this is the same as continuous measurement mode.	Measurement switch ON ↓ Refraction measurement (One measurement) ↓ When the measurement switch is held down, this is the same as continuous measurement mode.	Measurement switch ON ↓ Keratometry measurement (One measurement/center) ↓ When the measurement switch is held down, this is the same as continuous measurement mode.	Measurement switch ON ↓ Keratometry measurement (One measurement/center and periphery) ↓ When the measurement switch is held down, this is the same as continuous measurement mode.	Measurement switch ON ↓ Keratometry measurement (One measurement/center and periphery) ↓ Refraction measurement (One measurement) ↓ When the measurement switch is held down, this is the same as continuous measurement mode.
Quick measurement mode (→ P.20) This is the same as continuous measurement mode except that refraction measurements take about half the time. The length of time required for keratometry measurement does not change in this mode.	Auto start ↓ The following set is performed continuously: Keratometry measurement (One measurement/center) ↓ Quick refraction measurement (5 measurements)	Auto start ↓ Refraction quick measurement (Continuous measurements)	Auto start ↓ Keratometry measurement (One measurement/center)	Auto start ↓ Keratometry measurement (One measurement/center and periphery)	Auto start ↓ The following set is performed continuously: Keratometry measurement (One measurement/center and periphery) ↓ Quick refraction measurement (5 measurements)

3 - 1 Auto Measurement Mode

- 1 Press **A-C-M QUICK/4** and set the measurement mode to **A**.
- 2 Press **R-K/1** and select the R-K mode. The following description is for when the R-K mode selected is **RK**. The measurements made (refraction measurement, keratometry center measurement, keratometry peripheral measurement) differ for each R-K mode. For details on the measurements made in each R-K mode, see the previous page.
- 3 Show the patient where to sit. Ask the patient to rest both hands on the lap.
Adjust the height of the table or chair so the patient is comfortable.
- 4 Turn the chin rest height adjustment knob, and align the patient's eyes with the height guide ring.
- 5 Fit the patient's forehead to the forehead rest and rest the patient's chin firmly on the chin rest.
 - If the chin is not firmly in place, accurate measurement is not possible.
- 6 Move the joystick lever to position the measuring head so that the patient's eye is displayed on the screen. Once the patient's eye first appears on the screen, bring the image of the pupil to the center of the screen. (You may measure either eye first).

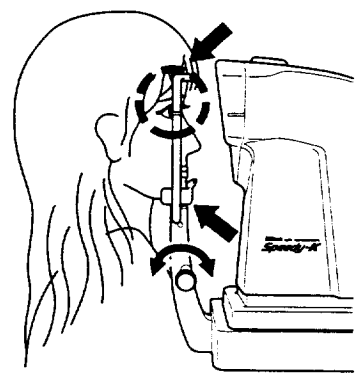

The following operations allow you to find the patient's eye easily

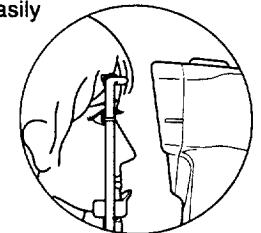

For vertical direction:
Align the head height mark with the height guide ring located on the chin rest bar.

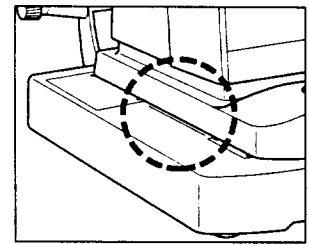

For lateral direction:
Align the edge of the sliding seat with the target line on the base.

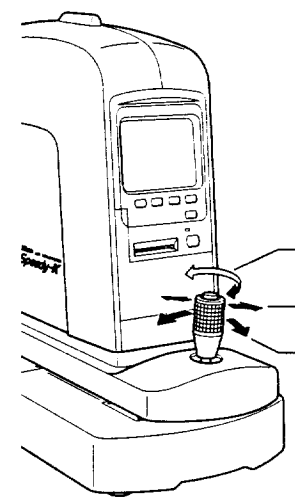

- Turn: Moves vertically.
- Tilt to left/right: Moves to left/right.
- Tilt to back/forth: Moves to back/forth.

Movement of the joystick lever and the measuring head motion

- 7 Before putting the light spot inside the alignment mark, move the joystick lever back and forth to focus the mire ring.

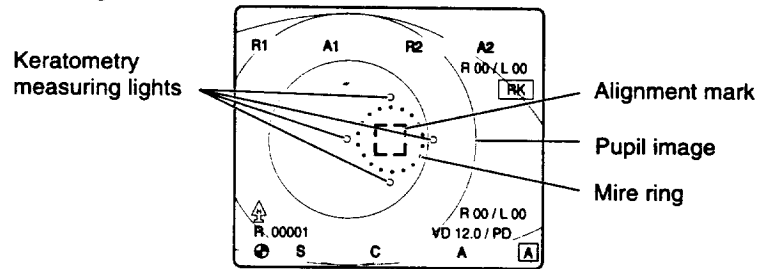

- 8 Once the mire ring is in focus, move the joystick to fine adjust the vertical and horizontal position to align the light spot with the center of the mire ring.

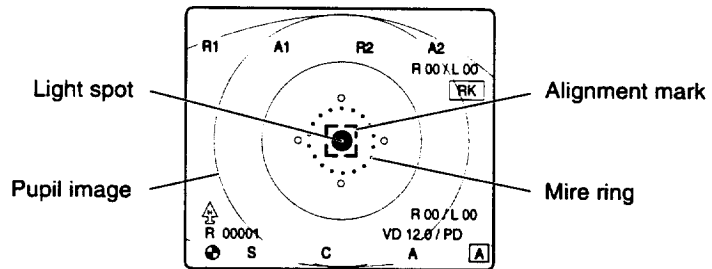

- 9 When the light spot enters the alignment mark, a "△" mark will appear indicating that Auto Fogging is activated.

If the light spot and mire ring are not clearly in focus, fine adjust by moving the joystick back and forth to achieve focus of the light spot and mire ring.

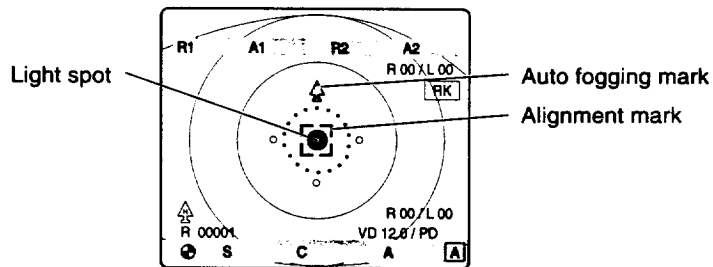

CAUTION Be careful not to bump the measuring head against the patient's nose when moving the unit left or right. (It is safe to move the unit left or right after first pulling it forward.)

10 When the “ $\frac{\Delta}{S}$ ” disappears, measurement will start automatically.

The unit will determine the cause of fluctuations in the measured values and will automatically end the measurement when measured values stabilize. The display on the TV monitor will be as in the figure below. (The figure is an example after the right eye has been measured.)

If you want to re-measure the right eye, press the measurement switch again at this point.

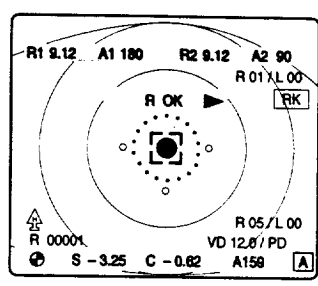

11 Move the unit left or right and perform steps 6 through 10 for measuring the other eye. If the AUTO PRINT setting is ON, the unit will automatically print out the measurement results once the measurement is finished. (→ P.21)

(The figure is an example of the TV screen during printing.)

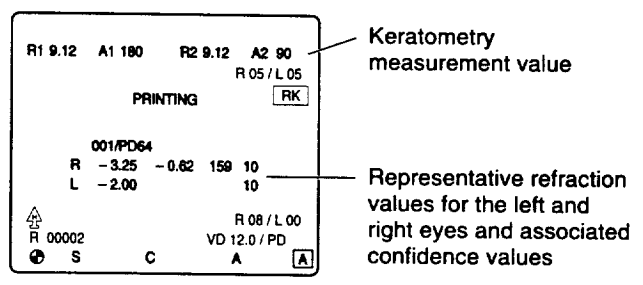

- After both eyes have been measured, the patient's PD value (pupil distance in mm) will be calculated. You may not obtain an accurate PD value in the following cases.
 - The patient's head moved during measurement.
 - The binocular function of the patient is not good.

- If there is any foreign matter (such as opacity in the crystalline lens caused by cataract, other opacity or scratches) obstructing the light from entering the pupil during measurement, it will appear as a black shadow. If there are any black shadows, observe the pupil in retro illumination mode (→ P.28) and proceed to further examination of the eye using the slit lamp.

3 - 2 Continuous Measurement Mode

- 1 Press **A-C-M QUICK /4** and set the measurement mode to **C**.
- 2 Press **R-K /1** and select the R-K mode.
- 3 Measure the patient's eyes using the same steps **3** through **10** as given in "3-1 Auto Measurement Mode".
 - In this mode, measurement does not end automatically, rather it is continuous.
 - Be sure to measure each eye at least five times.
 - Increase the number of measurements even more if there are fluctuations in the measured values or lots of eye movement.
 - Up to eight refraction and keratometry measurement results can be stored per eye.
- 4 Press the measurement switch when you want to end measurement for a given eye.
(The alignment mark will blink and measurement will stop temporarily.)
- 5 Measure the other eye in the same way.
- 6 Press the **PRINT** key when you want to print out the measurement results. (→ P.21)

3 - 3 Manual Measurement Mode

- 1 Press **A-C-M QUICK/4** and set the measurement mode to **M**.
- 2 Press **R-K/1** and select the R-K mode.
- 3 Position the measuring head versus the patient's eye using the same steps **3** through **8** as given in "3-1. Auto Measurement Mode".
 - In this mode, Auto Fogging does not activate even when the light spot enters the alignment mark.
- 4 If the light spot and mire ring are not clearly in focus, fine adjust by moving the joystick back and forth to achieve focus of the light spot and mire ring.
At this time, the fixation chart will automatically move slightly away from the far point of the patient's eye and an OK mark (→ OK ←) will appear.

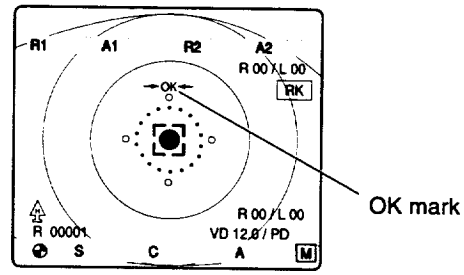

- 5 Press the measurement switch when the OK mark (→ OK ←) appears.
Auto Fogging will activate at this point and the patient's eye will be measured.
 - Be sure to take refraction measurements for each eye at least five times. Continuous measurement is possible by holding down the measurement switch.
Up to eight refraction and keratometry measurement results can be stored per eye.
- 6 Measure the other eye in the same way.
- 7 Press the **PRINT** key when you want to print out the measurement results. (→ P.21)

3 - 4 Quick Measurement Mode

Quick Measurement Mode with shortened refraction measurement times is useful such as when measurement is difficult due to quick motion of the eye in the case of an infant or nystagmus.

- Although the refraction measurement time in this mode is reduced to about half of the usual time, fluctuations in measured values may increase greatly.
- The length of time required for keratometry measurement does not change in Quick Mode.
- Do not use this mode under normal conditions.
- A "Q" is printed on the print paper to indicate Quick Measurement Mode.

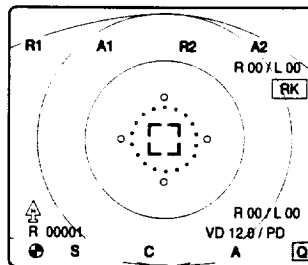

- 1 Press **A-C-M QUICK/4** and set the measurement mode to **Q**.
- 2 Press **R-K/1** and select the R-K mode. (Keratometry measurement is not available in Quick Measurement Mode.)
- 3 Position the measuring head versus the patient's eye using the same steps **3** through **10** as given in "3-1. Auto Measurement Mode".
 - In this mode, measurement does not stop automatically. Measurement is continuous.
 - Be sure to take quick refraction measurements for each eye at least five times.
Increase the number of measurements even more if there are fluctuations in the refraction measurement values or lots of eye movement. Up to eight refraction and keratometry measurement results can be stored per eye.
- 4 Press the measurement switch to end measurements for a given eye.
(The alignment mark will blink and measurement will stop temporarily.)
- 5 Measure the other eye in the same way.
- 6 Press the **PRINT** key when you want to print out the measurement results. (→ P.21)

3 - 5 Printing

- 1 In Auto Measurement Mode, if the AUTO PRINT setting is set to ON, measurement results are printed automatically after measurements are completed.
 In Continuous or Manual Measurement Mode, or when the AUTO PRINT setting is set to OFF, press the  key to obtain a printout.
 Communications with external devices conform to the communications settings made. (→ P.43)
 Data is printed according to user settings. (→ P.33)
 - The unit prints out only the measured results for the last eight measurement cycles for both refraction and keratometry measurements of each eye. (Five cycles for each eye in Auto Measurement Mode.)
 - Measurement cannot be performed during printout.
 - If Auto Print is set to OFF, a screen like that shown below will appear after both eyes have been measured. (Example during Auto Measurement)

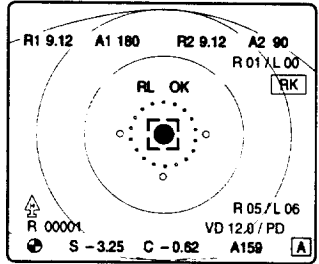

- 2 The printed paper will come out of the unit. Tear off the paper by pulling upward.

Example of Printed Data

Patient's No. No. 00113
 Name: '02. 4. 9 11:27 AM
 Date and time of measurement

Cornea vertex distance VD:12.0 PD:67.0 CHART:H
 Fixation chart brightness

Pupil distance -REF-

Measured refraction values (right eye)
 (R) SPH CYL AX
 -2.50 -1.12 114
 -2.50 -1.12 114
 -2.50 -1.12 115
 -2.62 -0.87 113
 -2.50 -1.00 114
 -2.50 -1.00 114
 -2.50 -1.12 114
 -2.50 -1.00 114

Representative refraction values (right eye)
 * -2.50 -1.00 114 10
 (S + C / 2 = -3.00)
 Spherical equivalent for right eye

Measured refraction values (left eye)
 (L) SPH CYL AX
 -1.87 -0.87 52
 -1.87 -0.87 54
 -1.87 -0.87 54
 -1.87 -0.87 53
 -1.75 -0.87 53
 -1.87 -0.87 51
 -1.87 -0.87 53
 -1.87 -0.87 53

Representative refraction values (left eye)
 * -1.87 -0.87 53 10
 (S + C / 2 = -2.25)
 Spherical equivalent for left eye

Measured keratometry values (right eye)
 (R) R1 R2 AX1 AX2
 8.38 8.12 42 132
 8.37 8.13 41 131
 8.39 8.12 42 132
 8.40 8.14 43 133
 8.39 8.12 42 132
 8.38 8.13 41 131
 8.37 8.12 42 132
 8.37 8.12 42 132

Representative keratometry values (right eye)
 * -8.38 8.13 41 131
 mm D deg
 R1 8.36 40.25 41
 R2 8.13 41.50 131
 AV 8.26 40.87
 CYL -1.25 41

Measured keratometry values (left eye)
 (L) R1 R2 AX1 AX2
 8.44 8.14 40 130
 8.44 8.14 40 130
 8.45 8.13 40 130
 8.44 8.14 40 130
 8.45 8.14 40 130
 8.44 8.14 40 130
 8.45 8.14 40 130
 8.44 8.14 40 130

Representative keratometry values (left eye)
 * -8.44 8.14 40 130
 mm D deg
 R1 8.44 40.00 41
 R2 8.14 41.50 131
 AV 8.29 40.75
 CYL -1.25

Right eye horizontal center measurement value
 (R) H mm D
 H 7.95 42.50
 V 7.79 43.37

Right eye vertical center measurement value
 PERI (25°)
 mm D
 T 7.96 42.37
 N 8.03 42.00
 S 7.99 42.25
 I 8.02 42.12
 E (H) = 0.267
 E (V) = 0.606
 E (AV) = 0.461

Left eye horizontal center measurement values
 (L) H mm D
 H 7.89 47.75
 V 7.71 43.75

Left eye vertical center measurement values
 PERI (25°)
 mm D
 T 7.90 42.75
 N 7.92 42.62
 S 7.94 42.50
 I 8.00 42.25
 E (H) = 0.190
 E (V) = 0.673
 E (AV) = 0.499

Right eye eccentricity
 This value is used for comparing the central curvature versus the peripheral curvature. The meaning is as follows.
 • About 0.5 is normal.
 • The eye approaches a spherical shape as this value approaches 0.
 • Peripheral sagging is higher as this value approaches 1.
 Use this information as a reference when selecting contact lenses.

Left eye eccentricity





Message area
 NIKON SPEEDY-K
 NIKON SPEEDY-K NIKON SPEEDY-K

User settings in this example:
 REF PRINT: ALL
 KER PRINT: ALL
 MESSAGE: ON
 TIME SETTING: 12-hour display
 R-K Mode: RKP

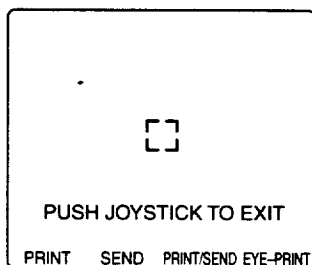
Radius curvature during right eye periphery measurement (tangential direction)
 Radius curvature during left eye periphery measurement (tangential direction)
 Refractive power of cornea (right eye periphery measurement)
 Refractive power of cornea (left eye periphery measurement)

- 3 Press the  key again if after printing you want to re-print (or resend) the data or if you want to make an eye print. The following screen will appear.



- Pressing  will re-print the measured results.
- Pressing  will resend the data. (→ P.43)
- Pressing  will re-print and resend the data. (→ P.43)
- Pressing  will make an eye print.

Example of Eye Print Data



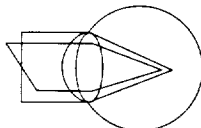
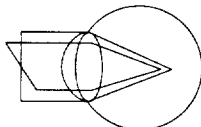

```

-- No. 00113 -----
                '02. 4. 9  11:27AM
Name:
VD:12.0  PD:67.0  CHART:H
[R]  SPH  CYL  AX
*   -2.50 -1.00 114  10

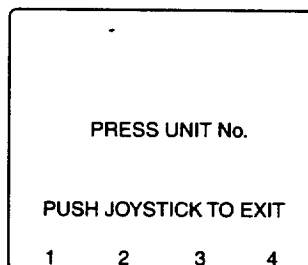
[L]  SPH  CYL  AX
*   -1.87 -0.87  53  10

AUTOREFRACTOKERATOMETER
SPEEDY-K
    
```

- 4 After printing, the following screen will appear if the RV IR ID setting (infrared transmission setting when there is more than one Auto Optester) is "SELECT". (→ P.39)

Select the ID number of the Nikon Auto Optester "Remote Vision" you want to send the data.





- Pressing  will send data to the Remote Vision with Unit No. "1".
- Pressing  will send data to the Remote Vision with Unit No. "2".
- Pressing  will send data to the Remote Vision with Unit No. "3".
- Pressing  will send data to the Remote Vision Unit with No. "4".

For details on setting the unit number for Nikon Auto Optester "Remote Vision", please refer to the Remote Vision instruction manual.

3 - 6 Miscellaneous

■ Automatic Fogging

The auto fogging mechanism aids measurement by facilitating patient eye fixation and minimizing eye accommodation.

In Auto Measurement or Continuous Measurement Mode, a  mark will appear on the monitor screen and auto fogging will be automatically activated when the light spot enters the alignment mark. When auto fogging ends, the  mark will disappear and measurement will automatically start.

In Manual Measurement Mode, pressing the measurement switch after the OK mark (→ OK ←) appears will activate auto fogging and measurement will be performed.

■ IOL Patients

This unit can measure IOL patient using the same procedure as normal eyes without any switching of switches.

■ When Keratometry Measurement is Impossible

When keratometry measurement is impossible, particularly when peripheral keratometry measurement is impossible, check that the eyelashes or eyelids are not blocking the measuring light. Have the patient open their eyes wide so that the measuring light is not blocked and then take the measurement.

During refraction-keratometry or keratometry measurement, keratometry measuring lights will appear on the patient's cornea and can be seen on the TV monitor. (The diagram on the right depicts RK Mode.)

If these keratometry measuring lights cannot be seen, can only be partially seen, or appear hazy, the measuring light is being blocked. This may be due to blocking by the eyelashes or eyelids, blinking or pathology of the cornea.

If the nasal side (N) cannot be measured during peripheral keratometry measurement, check that the patient's face is facing straight-forward and that his or her nose is not blocking the measuring light.

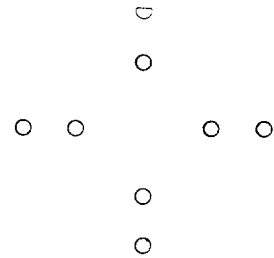
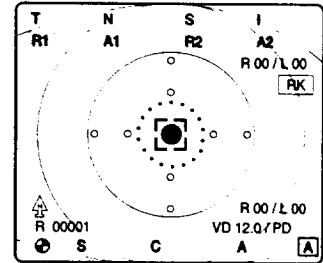

Example of blocked keratometry measuring lights

■ Measuring a Hard Contact Lens Base Curve

(The base curve of a soft contact lens cannot be measured.)

- 1 Place several drops of water on the supplied hard contact lens holder.
- 2 Place the hard contact lens on the holder (to face the side to be measured toward the instrument).
- 3 Mount the supplied model eye onto the forehead rest.

With the lens attached, install the hard contact lens holder onto the model eye.

- 4 Take measurements using normal keratometry measurement procedures.

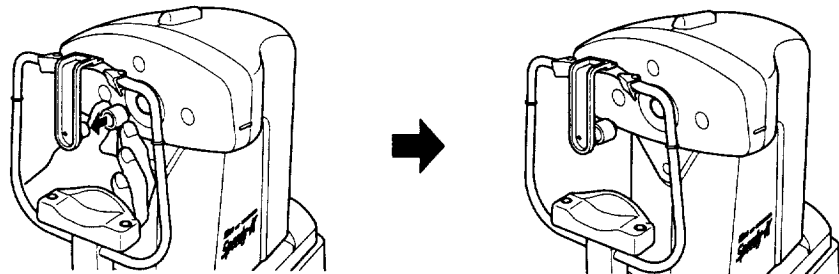
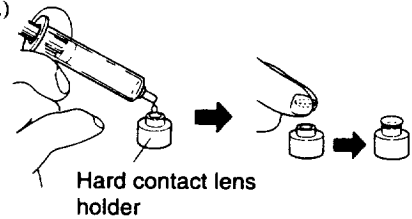

■ Error Messages

The following table summarizes possible causes on the right when an error message appears on the screen. Methods of dealing with problems are given below the table.

Error message	Cause
AL ERR	The optical axis of the unit is not aligned with the optical axis of the patient's eye.
RK ERR	Refraction and keratometry measurement values cannot be obtained for some reason even though alignment has been established. This may be due to eyelashes, blinking, irregular astigmatism, cataracts, small pupils, etc.
REF ERR	Refraction measurement values cannot be obtained for some reason even though alignment has been established. This may be due to eyelashes, blinking, irregular astigmatism, cataracts, small pupils, etc.
KER ERR	Keratometry measurement values cannot be obtained for some reason even though alignment has been established. This may be due to eyelashes, blinking, irregular astigmatism, cataracts, small pupils, etc.

- If an error message appears, align the light spot inside the alignment mark once more and press the measurement switch again.
- If a patient has drooped eyelashes, it will be necessary to make the eyelashes stay out of the outer line on the alignment mark on the TV monitor screen. If necessary, have the patient or an assistant gently lift the eyelid with their fingertip.
- In Manual Measurement Mode, it is good practice to press the measurement switch immediately after the patient blinks.
- The unit automatically re-measures if the patient blinks during measurement.
- The measurement may not be made if the patient is suffering from an eye disease such as a cataract, abnormal retina, opaque condition of the cornea, crystalline lens or vitreous body.
- If the patient's pupil is highly reactive to brightness, the fixation chart brightness setting should be reduced and then the eye measured. (→ P.30) The inner diameter of the mire ring is about 2.5 mm.
- When <S+C> is outside the range -18 to +23D, or when <C> is outside the range -12 to +12D, measurement cannot be made.
- Measurement with a contact lens on: Measurement is usually possible. However, if the contact lens is not properly fitted, the correct values may not be obtained. Any dirt or scratches on the contact lens surface may result in measurement failure.
- Measurement with glasses on: Measurement is possible if the lens is tilted slightly. If the lens is tilted at too large an angle, correct values will not be obtained. Measurement may not be possible if light is reflected from the lens surface into the measuring window, or if the glasses have a colored lens of low transmission.



■ Representative Values for Refraction and Keratometry Measurements

Representative values are a guide to help you choose which one of the several measured values for one eye to choose. An asterisk (*) indicates the representative values on a printout. For a sample printout, please see P.22. Consider the following points when selecting one value from several measured refraction values that vary widely.

- Substantial variance of SPH values

The patient's eye may be accommodating. Re-measure the eye.

- Substantial variance of CYL and AX values

AX will tend to be somewhat unstable when the eye is weak astigmatically (CYL value of less than 0.5D). Other causes may include the following.

- Eyelashes are occluding the pupil.
- The pupil diameter is less than the minimum measurable diameter of ϕ 2.5 mm.
- Part of the eye is opaque or irregular astigmatically.

Normally a low confidence value will be reported in the above situations.

If the eyelashes or pupil diameter affect the measurement, you should re-measure the eye paying close attention to these factors.

■ Refraction Confidence Values

A confidence value indicates how widely measured results vary. It is only displayed when measurements are made three or more times and is printed at the right of printed results. For a sample printout, please see P.22.

- 8 or higher: Variance is low
- 7 or less: There is variance. Care is required in the handling of these measured results.

■ Storing Measured Values

This unit can only store the representative values of refraction measurements for up to 100 patients. If an excess of representative values are stored, the older data will be deleted.

- In Auto Measurement Mode:

Data is automatically stored after measurements for right and left eyes are complete.

Press the  key after completing one eye, if you want to store data for one eye only.

- In Continuous or Manual Measurement Mode:

Data is stored when the  key is pressed after measurements for one or both eyes have been completed.

The next measurement is possible after data has been stored. The patient No. will increase by one at this time.

■ Automatic Power Conservation

The unit will automatically enter power conservation mode if no switches or keys have been operated for three or more minutes. Press any key when you need to make measurements again.



Retro Mode allows you to observe the inside of a pupil more easily and to more readily understand measurement status when the measured values vary or when the confidence value is low.

- 1 Press the **RETRO/2** key on the Measurement Mode screen.

The unit will enter Retro Mode.

In Retro Mode, fixation chart brightness is automatically switched to "L".

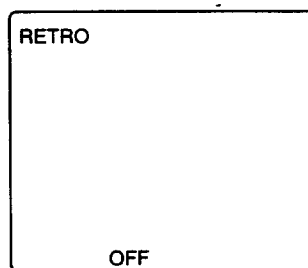

- 2 Align the position of the measuring head with the patient's eye and focus the image if not already focused.

If there is foreign matter obstructing the measuring light such as opacity in the crystalline lens, it will appear as a black shadow on the screen.

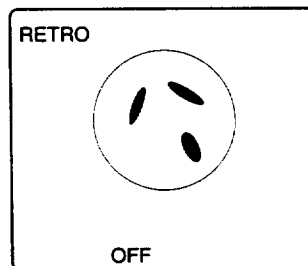

- Foreign matter in the pupil may be more clearly seen if the image of the patient's eye is decentered slightly. In particular, an opacity at the center may not be visible. Direct the measuring light so that it is not obstructed by an opacity.
- If an external illumination such as a fluorescent room lamp enters the patient's eye, foreign matter in the pupil may not be visible. Be sure that no external light enters the patient's eye.

- 3 Pressing the **RETRO/2** key will cancel Retro Mode and resume the previous measurement mode.



Making Various Settings (Setup)



The following settings can be made for this unit.

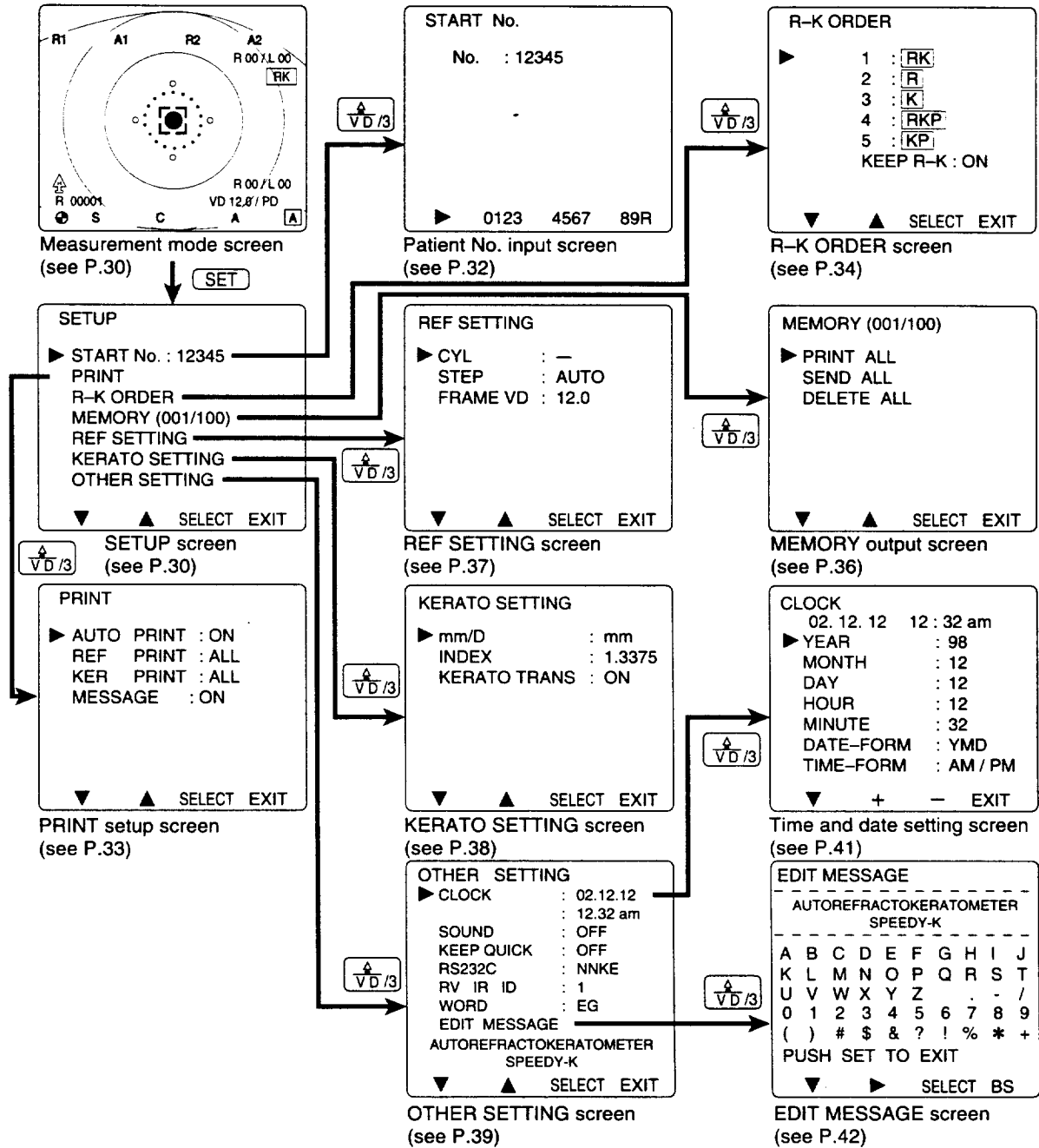

5 - 1 Measurement Mode Screen

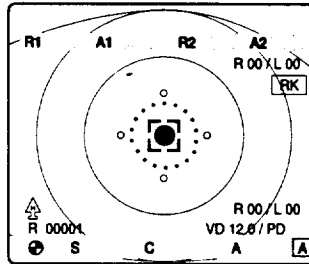

"Select R-K mode", "Enter retro mode", "Change fixation chart brightness", and "Change VD value" operations are performed on this screen.

R-K/1: Selects the R-K mode. RK → RKP → R → K → KP → RK...

RETRO/2: Enters retro mode. (→ P.28)

VD/3: Changes fixation chart brightness (press a short time). H (bright) → L (dark) → H (bright)...
Changes the VD value (press a long time). 12.0 → 0.0 → 12.0...

A-C-M QUICK/4: Switches the measurement mode. Auto → Continuous → Manual → Quick → Auto...

SET: Goes to the "SETUP Screen" (see below).

5 - 2 SETUP Screen

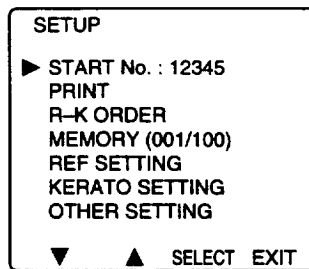

The following settings can be made on the "SETUP screen".

Use the **R-K/1** and **RETRO/2** key to move the cursor to the item you want to set, and use the **VD/3** key to select that item. Use the **A-C-M QUICK/4** key to store the setting data and return to measurement mode.

Item	Setting Description
START NO.	Pressing $\frac{\Delta}{\nabla D / 3}$ when the cursor is at this item position will bring up the "Patient No. Input Screen".
PRINT	Pressing $\frac{\Delta}{\nabla D / 3}$ when the cursor is at this item position will bring up the "PRINT Setup Screen".
R-K ORDER	Pressing $\frac{\Delta}{\nabla D / 3}$ when the cursor is at this item position will bring up the "R-K ORDER Screen".
MEMORY	Pressing $\frac{\Delta}{\nabla D / 3}$ when the cursor is at this item position will bring up the "MEMORY Output Screen".
REF SETTING	Pressing $\frac{\Delta}{\nabla D / 3}$ when the cursor is at this item position will bring up the "REF SETTING Screen".
KERATO SETTING	Pressing $\frac{\Delta}{\nabla D / 3}$ when the cursor is at this item position will bring up the "KERATO SETTING Screen".
OTHER SETTING	Pressing $\frac{\Delta}{\nabla D / 3}$ when the cursor is at this item position will bring up the "OTHER SETTING Screen".

5 - 3 Patient No. Input Screen

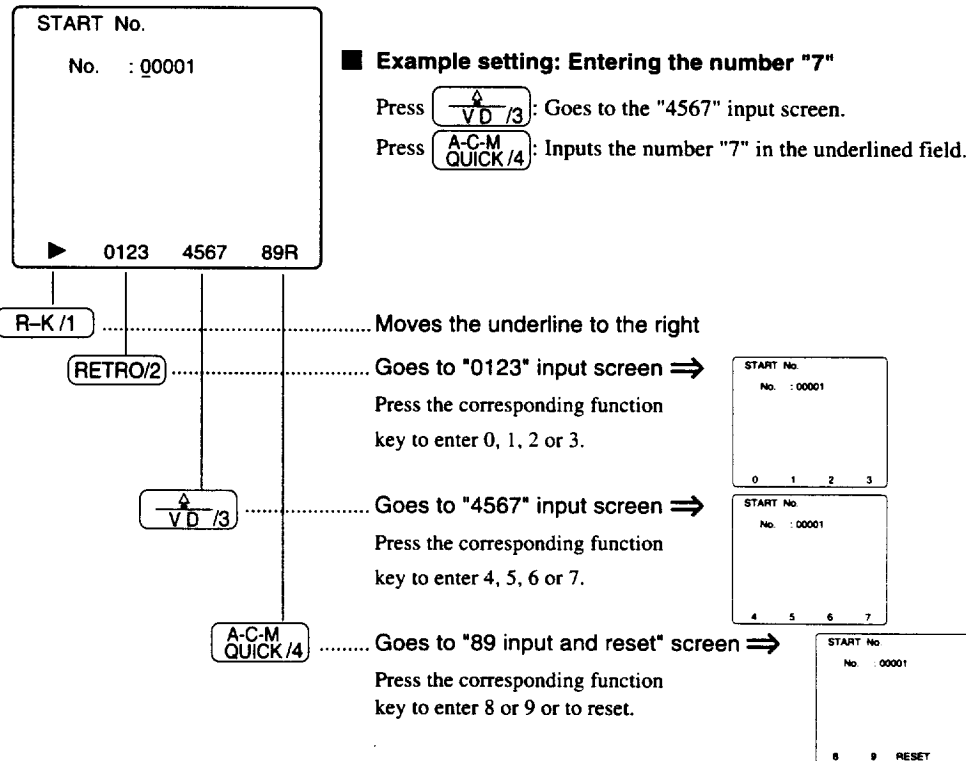

Pressing $\frac{\Delta}{VD/3}$ on the "SETUP screen" when the cursor is at "START No." will bring up the "Patient No. input screen".

Pressing a function key on this screen will display a "number input screen". Press the function key corresponding to the desired number to enter that number in the underlined field.



- The underline will go down one digit each time a number is input.
- To reset the patient No. to 00001, press the $\frac{\Delta}{VD/3}$ key on the "89 input and reset" screen.
- Pressing the **SET** key after setting all digits will return to the "SETUP screen".
- Once a patient No. is set, all patient numbers will be automatically increased by "1" for subsequent measurements.
- This screen is designed to enter the highest order digit first.

5 - 4 Print Setup Screen

Pressing  when the cursor is at the "PRINT" item position on the "SETUP Screen" will bring up the "PRINT Setup Screen". This screen is used to select print settings. Select setting contents by moving the cursor to the item you want to set and pressing the  key. Pressing  will return to the "SETUP Screen".

```

PRINT
▶ AUTO PRINT : ON
REF PRINT : ALL
KER PRINT : ALL
MESSAGE : ON

▼ ▲ SELECT EXIT
    
```

Auto print setting for Auto Measurement Mode:

ON → OFF → ON...

ON: Performs Auto Print during Auto Measurement Mode

OFF: Does not perform Auto Print during Auto Measurement Mode.

Print setting for measured refraction values:

ALL → REP → OFF → ALL...

ALL: Prints measured values and representative values if there are measured refraction values.

REP: Prints representative values if there are measured refraction values.

OFF: Does not print.

Print setting for measured keratometry values:

ALL → REP → OFF → ALL...

ALL: Prints measured values and representative values if there are measured keratometry values.

REP: Prints representative values if there are measured keratometry values.

OFF: Does not print.

Print setting for messages: ON → OFF → ON...

ON: Print messages.

OFF: Do not print messages.

 : Moves the cursor down.

 : Moves the cursor up.

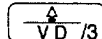
 : Selects setting contents for the item at the cursor position.

 : Returns to the "SETUP Screen".

5 - 5 R-K ORDER Screen

Pressing $\frac{\Delta}{\nabla D} / 3$ when the cursor is at the "R-K ORDER" position on the "SETUP Screen" will bring up the "R-K ORDER Screen". This screen is used for the R-K Mode Setting.

What is the R-K Mode Setting?

The unit switches to another R-K mode when the $R-K/1$ key is pressed while on the measurement screen. "R-K Mode Setting" refers to the types of R-K modes which can be selected for measurement and their switching order.

It is possible to set up to five modes.

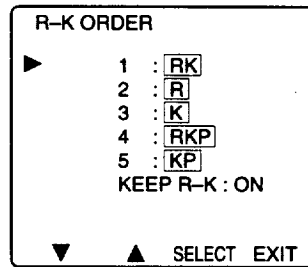

The figure above shows factory settings.

- $R-K/1$: Moves the cursor down.
- $RETRO/2$: Moves the cursor up.
- $\frac{\Delta}{\nabla D} / 3$: Selects setting item at the cursor position.
- $A-C-M$
 $QUICK/4$: Returns to the "SETUP Screen".

The setting will change in the order $RK \rightarrow R \rightarrow K \rightarrow RKP \rightarrow KP \rightarrow \dots$ with every depression of $\frac{\Delta}{\nabla D} / 3$ when the cursor is positioned at one of the locations 1 through 5. The cursor is moved using $R-K/1$ or $RETRO/2$.

- RK : After keratometry measurement (center), refraction measurements are made.
- R : Only refraction measurements are made.
- K : Only keratometry (center) measurements are made.
- RKP : After keratometry measurement (center and periphery), refraction measurements are made.
- KP : Keratometry measurements (center and periphery) are made.

■ Example: To set the R-K Mode Setting to **RK** → **R** → **K** → **KP**.

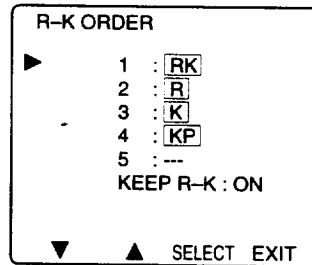

Move the cursor to 1 using **R-K/1** and/or **RETRO/2**, and select **RK** using **VD/3**.

Move the cursor to 2 using **R-K/1** and/or **RETRO/2**, and select **R** using **VD/3**.

Move the cursor to 3 using **R-K/1** and/or **RETRO/2**, and select **K** using **VD/3**.

Move the cursor to 4 using **R-K/1** and/or **RETRO/2**, and select **KP** using **VD/3**.

Press **A-C-M QUICK/4** and return to the "Setup Screen".

● "KEEP R-K" setting

If "KEEP R-K" is set to ON, the last R-K mode selected will be restored when the power is turned on again.

If "KEEP R-K" is set to OFF, the mode assigned to the first mode given by the R-K ORDER setting (among 1 to 5) will be restored when the power is turned on again.

5 - 6 Memory Output Screen

Pressing $\frac{\Delta}{VD/3}$ on the "SETUP screen" when the cursor is at "MEMORY" will bring up the "memory output screen". From this screen, it is possible to print, delete or send via RS-232C all past measured value data (for up to 100 patients) stored by the unit.

- Data cannot be selected.
- The number in parentheses next to "MEMORY" indicates the number of data entries currently stored.

Position the cursor next to the desired item and press the $\frac{\Delta}{VD/3}$ key to execute that function.

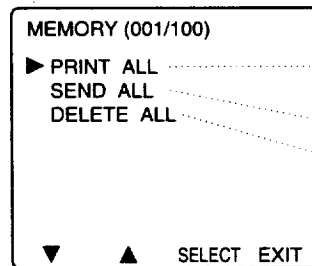

- Prints all stored data including representative values, dates, ID Nos. and so on in a list format.
- Sends all stored data to another device.
- Deletes all stored data.

$\frac{R-K}{1}$: Moves the cursor down.

$\frac{RETRO}{2}$: Moves the cursor up.

$\frac{\Delta}{VD/3}$: Selects setting contents for the item at the cursor position.

$\frac{A-C-M}{QUICK/4}$: Returns to the "SETUP Screen".

- A confirmation screen such as the following will appear if you attempt to execute "DELETE ALL". Press $\frac{R-K}{1}$ (YES) to delete all data. Press $\frac{RETRO}{2}$ (NO) if you do not wish to delete all data. After this screen, the unit will return to "memory output screen".

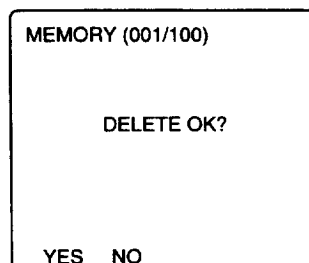

5 - 7 Ref Setting Screen

Pressing $\frac{\Delta}{VD/3}$ when the cursor is at the "REF SETTING" item position on the "SETUP Screen" will bring up the "REF SETTING Screen". This screen is used to make refraction measurement settings.

Move the cursor to the item you want to set and select settings using the $\frac{\Delta}{VD/3}$ key.

Pressing $\frac{A-C-M}{QUICK/4}$ will return to the "SETUP Screen".

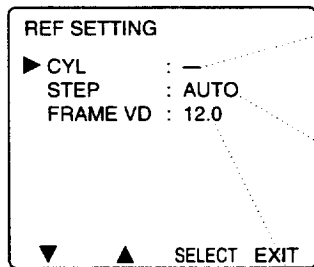

Astigmatism sign setting: - → ± → + → -...

-: Minus display for astigmatism sign

±: Mixed display for astigmatism sign

+: Plus display for astigmatism sign

Measurement value (S, C) display step setting:

AUTO → 0.25 → 0.12 → AUTO...

AUTO: A 0.12D step is used to display the measured values within the range +/-3D.

A 0.25D step is used to display the values outside this range.

0.25: 0.25D step

0.12: 0.12D step

Corneal vertex distance setting:

12.0 → 13.5 → 13.75 → 15.0 → 16.0 → 0 → 12.0...

$\frac{R-K}{1}$: Moves the cursor down.

$\frac{RETRO}{2}$: Moves the cursor up.

$\frac{\Delta}{VD/3}$: Selects setting contents for the item at the cursor position.

$\frac{A-C-M}{QUICK/4}$: Returns to the "SETUP Screen".

5 - 8 Kerato Setting Screen

Pressing $\frac{\Delta}{VD/3}$ when the cursor is at the "KERATO SETTING" item position on the "SETUP Screen" will bring up the "KERATO SETTING Screen". This screen is used to make keratometry measurement settings.

Move the cursor to the item you want to set and select settings using the $\frac{\Delta}{VD/3}$ key.

Pressing $\frac{A-C-M}{QUICK/4}$ will return to the "SETUP Screen".

KERATO SETTING	
▶ mm/D	: mm
INDEX	: 1.3375
KERATO TRANS	: ON
▼	▲
SELECT EXIT	

Display unit setting: mm → D → mm...

Setting for refractive power of the cornea during D conversion:
1.3375 → (1.332) → (1.336) → 1.3375

Transmission setting for measured keratometry values:
ON → OFF → ON...

(This setting indicates whether or not measured keratometry values should also be sent when using RS-232C or infrared transmissions.)

$\frac{R-K/1}{}$: Moves the cursor down.

$\frac{RETRO/2}{}$: Moves the cursor up.

$\frac{\Delta}{VD/3}$: Selects setting contents for the item at the cursor position.

$\frac{A-C-M}{QUICK/4}$: Returns to the "SETUP Screen".

5 - 9 OTHER SETTING Screen

Pressing $\frac{\Delta}{VD/3}$ on the "SETUP screen" when the cursor is at "OTHER SETTING" will bring up the "OTHER SETTING screen".

From this screen, the following settings can be made.

Move the cursor to the item you want to set and select settings using the $\frac{\Delta}{VD/3}$ key.

Pressing $\frac{A-C-M}{QUICK/4}$ will return to the "SETUP Screen".

OTHER SETTING	
▶ CLOCK	: 02.12.12
	: 12.32 am
SOUND	: OFF
KEEP QUICK	: OFF
RS232C	: NNKE
RV IR ID	: 1
WORD	: EG
EDIT MESSAGE	
AUTOREFRACTOKERATOMETER	
SPEEDY-K	
▼	▲
SELECT EXIT	

5. Making Various Settings (Setup)

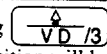
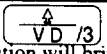
Item	Setting Description	Available Selections
CLOCK	Pressing  when the cursor is at this item position will bring up the "time and date setting screen". (→ P.41)	—
SOUND	Turns the sound ON/OFF.	ON → OFF → ON...
KEEP QUICK	If Quick Measurement Mode has been set and power is turned off, this setting indicates whether or not Quick Measurement Mode should be restored when power is turned on again. • ON: Restore Quick Measurement Mode. • OFF: Do not restore Quick Measurement Mode.	ON → OFF → ON...
RS-232C	Sets the data to transmit on the RS-232C port. • OFF: Select this when nothing is connected to the RS-232C. • NNKE: Select this when connected to an Auto Optester "Remote Vision". • NK: Select this when connected to an Auto Optester "OT3A", "7A" or "8A". • PC: Select this when connected to a PC. • E1 to E5: Reserved for future use	OFF → NNKE → NK → PC → E1 → E2 → E3 → E4 → E5 → OFF...
RV IR ID	Sets the infrared communications destination when there is more than one Auto Optester "Remote Vision". • OFF: Select this when there are no infrared communications with a Remote Vision. • 1 to 4: Select the number of the Remote Vision with which you want to communicate. • SELECT: Select this when you want to select from more than one Remote Vision.	OFF → 1 → 2 → 3 → 4 → SELECT → OFF...
WORD	Sets the language to use in on-screen displays and printouts. (See table on next page.)	EG → DN → DU → FR → GR → HN → IN → IT → NR → PL → PR → SP → SW → TR → JP → EG...
EDIT MESSAGE	Pressing  when the cursor is at this item position will bring up the "EDIT MESSAGE screen". (→ P.42)	—

Available Settings for WORD





	RIGHT	LEFT	SPH		CYL		AXIS		PD	VD
EG (ENGLISH)	R	L	S	SPH	C	CYL	A	AX	PD	VD
DN (DANISH)	H	V	S	SPH	C	CYL	A	AX	PD	VD
DU (DUTCH)	R	L	S	SPH	C	CYL	A	AS	PD	VD
FR (FRENCH)	D	G	S	SPH	C	CYL	A	AXS	PD	VD
GR (GERMAN)	R	L	S	SPH	C	CYL	A	ACH	PD	VD
HN (HUNGARIAN)	J	B	S	SZF	C	CYL	T	TEN	PT	VT
IN (INDONESIAN)	KN	KR	S	SPH	C	CYL	A	AX	PD	VD
IT (ITALIAN)	D	S	S	SF	C	CYL	A	AS	PD	VD
NR (NORWEGIAN)	H	V	S	SPH	C	CYL	A	AXS	PD	VD
PL (POLISH)	P	L	S	SF	C	CYL	O	OS	RZ	VO
PR (PORTUGUESE)	D	E	E	ESF	C	CIL	E	EIXO	DP	DV
SP (SPANISH)	D	I	S	SPH	C	CIL	A	AXE	PD	VD
SW (SWEDISH)	H	V	S	SF	C	CYL	A	AX	PD	TA
TR (TURKISH)	R	L	S	SPH	C	CYL	A	AXS	PM	VM
JP (JAPANESE)	R	L	S	SPH	C	CYL	A	AX	PD	VD

↑ ↑ ↑
 Indication in printouts

5 - 10 Time and Date Setting Screen

Pressing  on the "OTHER SETTING screen" when the cursor is at "CLOCK" will bring up the "time and date setting screen". From this screen, the time, date, time display format, and date display format can be set.

<pre> CLOCK 02. 12. 12 12 : 32 am ▶ YEAR : 02 MONTH : 12 DAY : 12 HOUR : 12 MINUTE : 32 DATE-FORM : YMD TIME-FORM : AM / PM ▼ + - EXIT </pre>	<p>Year: 00 to 99 (last two digits of year)</p> <p>Month: 1 to 12 or Jan to Dec</p> <p>Day: 1 to 31</p> <p>Hour: 0 to 12 or 0 to 24</p> <p>Minute: 00 to 60</p> <p>Date display format: YMD (year/month/day), MDY (month/day/year), DMY (day/month/year), YMND (year/month name/ day), MNDY (month name/day/year), DMNY (day/ month name/year)</p> <p>Time display format: AM/PM, 24H</p>
---	---

-  : Moves the cursor down.
-  : Moves the cursor up.
-  : Selects setting contents for the item at the cursor position.
-  : Returns to the "SETUP Screen".

5 - 11 EDIT MESSAGE Screen

Pressing $\frac{\Delta}{VD/3}$ on the "OTHER SETTING screen" when the cursor is at "EDIT MESSAGE" will bring up the "EDIT MESSAGE screen".

From this screen, messages up to 24 characters by 2 lines (48 total characters) can be input.

Pressing the **SET** key will store the message and return to the "OTHER SETTING screen".

EDIT MESSAGE												

AUTOREFRACTOKERATOMETER												
SPEEDY-K												

A	B	C	D	E	F	G	H	I	J			
K	L	M	N	O	P	Q	R	S	T			
U	V	W	X	Y	Z	.	-	/				
0	1	2	3	4	5	6	7	8	9			
()	#	\$	&	?	!	%	*	+			
PUSH SET TO EXIT												
▼ ► SELECT BS												

$\frac{R-K}{1}$: Moves the cursor down.

$\frac{RETRO}{2}$: Moves the cursor up.

$\frac{\Delta}{VD/3}$: Selects the character at the cursor position.

$\frac{A-C-M}{QUICK/4}$: Goes back one space.



Connecting to External Devices



The power supply includes a connector for connecting to external devices. This connector is for interfaces which conform to the EIA RS-232C standard. It is possible to send measured results to external devices such as a Nikon Auto Optester or commercially available PC via this connector.

When a Nikon Auto Optester (such as OT3A, OT7A, OT8A or Remote Vision) is connected, the lens power data measured by Auto Refractometer is automatically transferred to the Auto Optester, allowing a speedier subjective examination.

If you create and run an appropriate software program on a PC, it is also possible to store data and statistically process it more efficiently.

For details on this interface, please contact your nearest Nikon representative.



Maintenance

7 - 1 Checking Measurement Accuracy

Before using this unit check its measurement accuracy using the model eye provided.

For details on how to measure using the model eye and checking accuracy, refer to "2. Preparation".

7 - 2 Replacing a Printer Paper Roll

When printer paper is about to run out, a red line will appear on the paper. In this case, replace the paper roll.

- 1 Turn the unit's power ON.
- 2 Push the "PUSH" part of the printer's cover, remove the cover, and remove the old roll.
- 3 Pull out the paper of the new roll past the location of the adhesive and crease it. Gently tear the paper along the crease. Tearing the paper in this way avoids printing on the part with adhesive. Also, if the sharp corners have been cut after tearing the paper, you can insert the paper more easily.

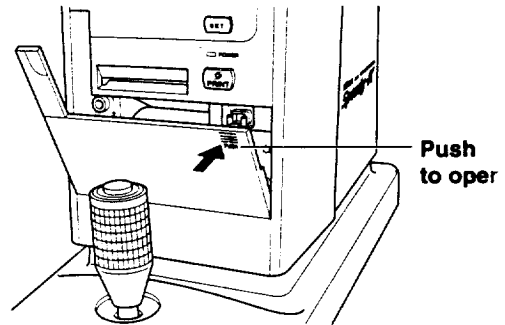

- 4 Press  to feed the paper. Insert printer paper into the feeding port as shown in the figure so that it will feed properly.

- Do not to insert the printer paper upside down.
- If the printer paper jams or is inserted at an angle, raise the release lever and adjust the position of the printer paper.
- The paper will not feed when the lever is raised.
- If the printer paper is used up during printing,

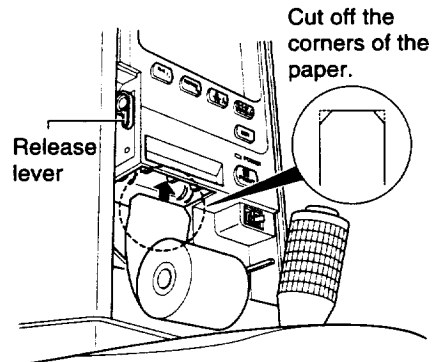

the message "PAPER END" will appear. If this happens, insert a new paper roll as previously described. Printing will start again from the beginning of the data. No key operations are accepted when the message "PAPER END" appears. Do not turn the unit's power OFF while the message "PAPER END" is displayed.

- 5 Replace the printer's cover.



7 - 3 Changing the Fuses



CAUTION Always turn the power switch OFF and unplug the power cord from the outlet before inspecting or changing fuses.

Use the following type of fuse for both fuses. Do not use any other type of fuse.

Spare fuses may be ordered from your nearest Nikon representative.

"Time lag fuse T1AL/250V"

SCHURTER 0034.3117

A fuse may be blown if the POWER lamp and/or fixation chart do not light or the TV screen does not brighten even though the power switch is ON.

Unfasten the tabs on both sides of the fuse holder with the tip of a small flat-top screwdriver. Remove the fuse from the fuse holder to check and replace it.

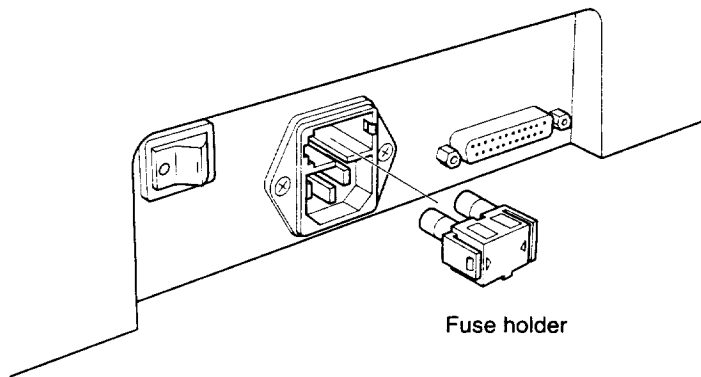



7 - 4 Cleaning the Chin and Forehead Rests

Be sure to clean the chin and forehead rests periodically. Wipe these surfaces with a soft cloth or tissue paper moistened with lens cleaning liquid or absolute alcohol (commercially available).

7 - 5 Cleaning the Measurement Window

The measurement window is dust-resistant glass. If any dust on the glass is visible from the patient side, use the blower provided to powerfully blow air several times to remove the dust. If the dust cannot be removed, wipe the glass with a lens cleaning liquid or absolute alcohol (commercially available).

- ⚠ Because the dust-resistant glass is thin and fragile, do not press it too hard.

7 - 6 Cleaning the Model Eye

Sometimes correct values cannot be obtained when measuring the model eye due to dust or fingerprints on the model eye's lens surface. If this occurs, gently wipe the lens surface with a clean and soft cotton cloth (such as gauze) moistened with a little cleaning solution or absolute alcohol (commercially available) taking care not to scratch the lens surface. (Never use a handkerchief or degreased cotton wool.)

- ⚠ A microscopic scratch on the lens surface of the model eye may reduce the accuracy of measurement.

Be careful not to bump the model eye against a hard object or drop it on the floor.

7 - 7 Cleaning the Painted Components

Do not use organic solvents (such as alcohol, ether, or paint thinner) on painted components, plastic components, or printed labels. Doing so could result in discoloration or in the peeling of printed characters. If the dirt is hard to remove, dampen a piece of gauze with a small amount of neutral detergent thinned with water, then wipe the dirty surface gently.



Troubleshooting



- Check the following items before requesting repairs.

Symptom	Check Point	Cause and Solution
POWER lamp does not light even though power is on.	Is the input power cord connected securely?	Securely connect the input power cord.
	Are the fuses blown?	If the fuses are blown, replace them. (→ P.45)
Cannot make measurements. Measured values are not stable.	Is foreign matter obstructing light inside the pupil?	Check the eye in Retro Mode. (→ P.28)
Does not print anything.	Are you using the specified paper?	Use the specified printer paper.
	Is the printer's release lever raised?	Lower the release lever toward you.
	Is the printer paper loaded upside down?	Insert the printer paper correctly. (→ P.44)
Paper is jammed. Paper does not come out easily.	Is the printer paper loaded correctly?	Insert the printer paper correctly. (→ P.44)
	Is the cover pressing on the printer paper?	Attach the cover correctly. (→ P.44)

- If any of the following errors appear on the screen, please contact your nearest Nikon representative as this indicates internal malfunction of the unit.

- ERR** (** represent numeral.)
- BACKUP ERR



Specifications

9 - 1 Measurements

● Refraction Measurements

Measurement range:	S+C: -18 to +23 Dp (measurement range for a VD value of 12) C: 0 to -12 Dp or 0 to +12Dp AX: 1 to 180°
Minimum unit:	S, C: Auto/0.25D/0.12D (switchable) AX: 1°
Minimum pupil diameter:	ø 2.5 mm
Measurement wavelength:	860 nm

● Keratometry Measurements

Measurement range:	Corneal radius curvature: 5 to 11 mm Corneal astigmatism: 0 to -12 Dp
Minimum unit:	Corneal radius curvature: 0.01 mm Corneal astigmatism: 0.12 Dp Cylindrical axis: 1°
Measurement area:	Center: 23°, ø 3.2 (radius 8 mm) Periphery: 50°, ø 6.8 (radius 8 mm)

● Common Functions (Measurement Time and Mode)

R-K mode:	Continuous measurement: RKP, RK Single measurement: KP, R, K
Measurement time:	Refractometer only: Time to acquire one measurement: 0.01 sec. Keratometry only: Time to acquire one measurement: 0.033 sec. Measurement time during continuous measurement: RKP: 0.45 sec/measurement at continuous measurement RK: 0.35 sec/measurement at continuous measurement KP: 0.25 sec/measurement at single measurement R: 0.2 sec/measurement at single measurement K: 0.15 sec/measurement at single measurement
Measurement mode:	Auto measurement: Contiguous operation of automatic start, stop, and print is possible without operating any keys. Continuous measurement: Keratometry stops automatically, refractometry is continuous. Manual measurement: Pressing the joystick one time results in one measurement, holding it down results in continuous measurement. Quick Measurement: Measurement is given priority over fogging to decrease the time required for refraction measurements.
Fixation chart:	Picture target
Fixation chart brightness:	2-level switchable illumination
Mire ring:	18-dot LED, ø 2.6 (at R8mm) for alignment



Retro illumination:	Pressing the RETRO/2 key turns off exterior illumination of the eye and causes alignment marks and other displays to disappear allowing retro illumination of the patient's eye for observation of cataracts, scratches, etc.
Corneal vertex distance:	0, 12, 13.5, 13.75, 15, 16 mm
PD measurement:	Up to 83 mm (depending on the sliding seat distance between left and right eyes) Unit of measurement: 1 mm
Left-right eye distinction:	Distinguished by measurement position versus the center of the sliding seat.

● **Measurement Accuracy**

Spherical and cylindrical power:	± 0.25 D or less for 0 to ± 10 D ± 0.5 D or less for less than -10D and larger than +10D
Radius curvature (center):	± 0.02 mm or less
Radius curvature (periphery):	± 0.05 mm or less

9 - 2 Main Body and Miscellaneous

Main unit dimensions:	254 (W) x 480 (D) x 473 (H) mm
Weight:	Approx. 17 kg
Input voltage:	AC 100 V, 120 V or 230 V (50/60 Hz common) Voltage set by voltage switcher
Power consumption:	0.5 A, 0.4 A or 0.2 A
Real-time clock:	Built-in real-time clock for printing the year, month, day, hour and minute
Interface:	RS-232C standard interface x 1 Infrared communications with Remote Vision
Printer:	58-mm wide line printer
Monitor:	5.5-inch black and white monitor
Power saving system:	Enters sleep mode if no keys are pressed for three minutes
Eye diagram printout:	Yes
Eye data memory:	Up to 100 patients
Classification of device (EN60825-1:1994):	Class1 LED product
Wavelength of LED:	855 to 870 nm
Radiation power:	245 μ Wmax
Chopped frequency:	600 Hz



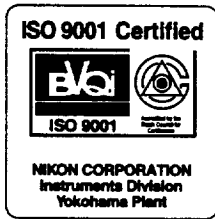

NIKON CORPORATION

9-16, Ohi 3-chome, Shinagawa-ku, Tokyo 140-8505, Japan
Tel: +81-3-3773-8121/8122 Fax: +81-3-3773-8115

NIKON INC.

Instrument Group

1300 Walt Whitman Road, Melville, NY 11747-3064, U.S.A.
Tel: +1-516-547-8500 Fax: +1-516-547-0306

NIKON EUROPE B.V.

Schipholweg 321, P.O. Box 222, 1170 AE Badhoevedorp, The Netherlands
Tel: +31-20-44-96-222 Fax: +31-20-44-96-298