

**INSTRUCTION MANUAL  
SLIT LAMP**

---

**SL-D2**

**SL-D4**

**SL-D4Z**

# INTRODUCTION

Thank you for purchasing the Slit Lamp SL-D2/SL-D4/SL-D4Z.

---

This slit lamp is used for enlargement in the observation of eyeballs and other parts.

**This instrument has the following features:**

- Smooth operation
  - Eye ground observation/recording with natural, clear colours
  - Function for automatic right/left eye detection, useful for digital recording
  - Apochromatic optical system to realize natural colour and high resolution
  - Robustness and durability
  - SL-D4Z makes continuous observation by manual zoom microscope possible.
- 

This Instruction Manual gives a summary of the basic operation, troubleshooting, checking, maintenance and cleaning of Slit Lamps SL-D2, SL-D4 and SL-D4Z.

To ensure the best use of the instrument, read "Displays for Safe Use" and "Safety Precautions". Keep this Instruction Manual with the instrument for future reference.

---

## PRECAUTIONS

### WORKING ENVIRONMENT

Temperature:	10°C-40°C
Humidity:	30-75% (no dewing)
Atmospheric Pressure:	700hPa-1,060hPa

### STORAGE METHOD

#### 1. Environmental Conditions

Temperature:	10°C-40°C
Humidity:	30-75% (no dewing)
Atmospheric Pressure:	700hPa-1,060hPa

#### 2. Place of Storage

- (1) Protected from water splashes
- (2) Protected from adverse effects caused by atmospheric pressure, temperature, moisture, ventilation, sunlight, dust, salt content, sulphur, etc.
- (3) Stable, without slopes, and protected from vibrations, shocks (including transportation), etc.
- (4) Free of chemicals and gases

### PERMISSIBLE ENVIRONMENTAL CONDITIONS FOR TRANSPORT AND STORAGE

Temperature: -20°C-50°C

Humidity: 10-95%

## **MAINTENANCE AND CHECKS**



1. Regularly maintain and check equipment and parts.
2. When using equipment for the first time in a while, check in advance that everything is operating as it should.
3. Keep the objective lens free of fingerprints and dust.
4. When not in use, protect the instrument with the dust cover.
5. If the objective lens is stained, clean it in accordance with the information under "Cleaning Lenses and Prisms" in the Instruction Manual.

# DISPLAYS FOR SAFE USE



In order to ensure the safe use of the product and to prevent danger to the operator and others, or damage to property, important warnings are placed on the product and described in the instruction manual.

All users are recommended to take note of the meaning of the following displays and icons before reading the "Safety Precautions" and text.

## DISPLAYS

DISPLAY	MEANING
 <b>WARNING</b>	Ignoring or disregarding this notice could lead to death or serious injury.
 <b>CAUTION</b>	Ignoring or disregarding this display could lead to personal injury or physical damage.
<ul style="list-style-type: none"><li>• Injury refers to cuts, bruises, sprains, fractures, burns, electric shocks, etc.</li><li>• Physical damage refers to damage to buildings, equipment or furniture.</li></ul>	













## ICONS

ICONS	MEANING
	This indicates Prohibition. Specific content is expressed via words or icons, with words either inserted in the icon itself or located next to the icon.
	This indicates Mandatory Action. Specific content is expressed via words or icons, with words either inserted in the icon itself or located next to the icon.
	This icon indicates Hazard Alert (Warning). Specific content is expressed via words or icons, with words either inserted in the icon itself or located next to the icon.

# SAFETY PRECAUTIONS



## CAUTION

Icons	Prevention item	Page
	"To prevent units from falling during use and movement, secure each unit."	<b>15</b>
	To avoid injury to the patient's eye and nose, pay particular attention while operating the instrument body.	<b>29</b>
	To prevent fingers from being caught between moving parts, beware of the moving parts while operating the main body.	<b>29</b>
	To avoid causing the patient pain and damage to the patient's eye, do not make the illumination too bright.	<b>30</b>
	To avoid electric shocks, do not attempt overhauling, rebuilding or repairs. Contact your dealer for repairs.	<b>39</b>
	When replacing the lamp, switch off the power supply and remove the power cable to avoid electric shocks.	<b>34</b>
	If you replace the lamp immediately after switching it off, beware of high temperatures: they could cause burns.	<b>34</b>
	When replacing fuses, first switch off the power supply and remove the power cable to avoid electric shocks.	<b>36</b>
	Before carrying out daily maintenance, remove the power cable (to avoid electric shocks) and wait until the body has cooled down (to avoid burns).	<b>37</b>
	To prevent burns, do not touch parts inside the lamp cover house during operation and immediately after switching off the power supply.	<b>37</b>
	The base contains strong springs. Do not attempt to disassemble or burn the base, as the springs could cause injury by shooting out of it.	<b>38</b>
	To prevent items from falling during use and movement, attach optional accessories securely.	<b>40</b>



## CAUTION

Icons	Prevention item	Page
	<p>This instrument has been tested (with 120V/230V) and found to comply with IEC60601-1-2: 2001.</p> <p>This instrument radiates radio frequency energy within standards and may affect other devices in the vicinity.</p> <p>If you have discovered that turning the instrument on or off affects other devices, we recommend you change its position, keep it at a proper distance from other devices, or change the outlet.</p> <p>If you have any questions, please contact the dealer who supplied the equipment.</p>	—

# MAINTENANCE

## USER MAINTENANCE

To ensure the safe operation of the instrument, all maintenance should be carried out by an authorized service engineer, unless otherwise specified in this manual.  
For details about maintenance, read the description of this manual.

### **REPLACING THE ILLUMINATION LAMP**

The illumination lamp can be replaced if necessary. For specific instructions, see page 34.

### **REPLACING THE FUSE**

Fuses on the primary side can be replaced, if necessary. For specific instructions, see page 36.

## **ESCAPE CLAUSE**

- TOPCON shall take no responsibility for damage due to fire, earthquakes, actions by a third party or other accidents, or the negligence and misuse of the user and use under unusual conditions.
- TOPCON shall take no responsibility for damage derived from the inability to use this equipment, such as a loss of business profit and suspension of business.
- TOPCON shall take no responsibility for damage caused by operations other than those described in this Instruction Manual.
- Diagnoses made are the responsibility of qualified doctors and TOPCON shall take no responsibility for the results of such diagnoses.



# WARNING INDICATIONS AND POSITIONS

To ensure safety, warning labels are provided on the instrument body.

Abide by these warning instructions. If any of the following labels are missing, contact your dealer or TOPCON (see the back cover).



**CAUTION**

- To prevent electric shocks, switch off the power supply and remove the power cable before replacing the lamp.
- Do not replace the lamp immediately after switching it off: the high temperatures could cause burns.



**CAUTION**

When operating the base unit, please note the following:

- Beware of catching fingers in the moving parts.
- Avoid hitting the patient's eyes or nose.

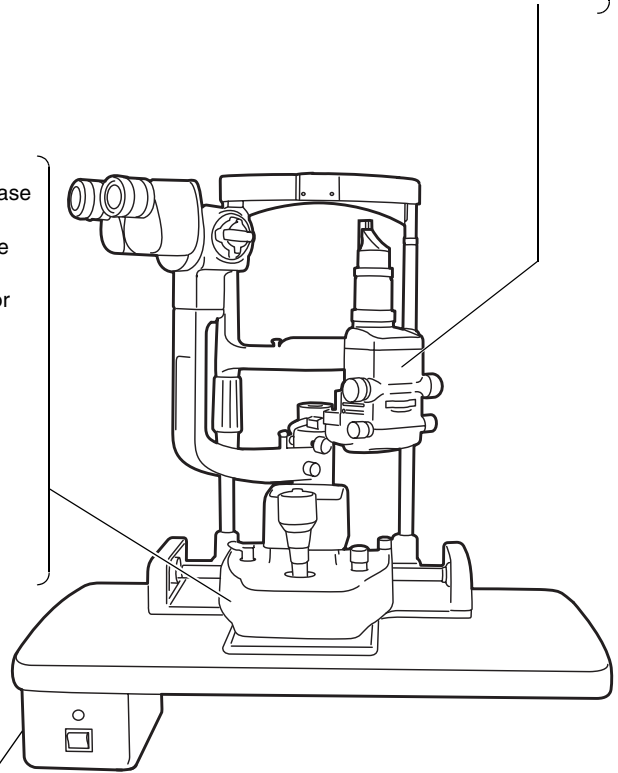

**CAUTION**

- To prevent electric shocks, turn off the power switch and remove the power cable before replacing fuses.
- Use the specified fuse.

# CONTENTS

INTRODUCTION .....	1
DISPLAYS FOR SAFE USE .....	4
SAFETY PRECAUTIONS .....	5
MAINTENANCE .....	7
USER MAINTENANCE .....	7
ESCAPE CLAUSE .....	7
WARNING INDICATIONS AND POSITIONS .....	8
<b>CONFIGURATION</b>	
NAMES OF MAIN BODY COMPONENTS .....	11
STANDARD ACCESSORIES .....	12
<b>COMPONENTS</b>	
COMPONENTS .....	14
<b>ASSEMBLY PROCEDURE</b>	
SECURING THE INSTRUMENT TYPE TABLE TOP .....	15
SECURING THE UNIT TYPE TABLE TOP .....	16
SECURING THE PATIENT GRIP PG-1 (OPTIONAL ACCESSORY) .....	16
SECURING THE CHINREST BASE PLATE .....	17
SECURING THE BASE UNIT AND RAIL COVER .....	17
SECURING THE BINOCULAR TUBES .....	18
SECURING THE ILLUMINATION UNIT .....	18
CONNECTING AND SECURING CABLES .....	20
FITTING THE CHINREST TISSUE .....	20
FITTING THE CAP .....	21
SECURING THE TONOMETER MOUNT (OPTIONAL ACCESSORY) .....	21
COUNTER-BALANCING THE VERTICAL MOVEMENT .....	23
<b>PREPARATIONS</b>	
POWERING ON .....	25
ADJUSTING THE DIOPTER AND PUPILLARY DISTANCE (PD) .....	25
<b>OPERATION PROCEDURES</b>	
FIXING THE PATIENT'S FACE AND FIXATION .....	28
OPERATING THE MICROSCOPE UNIT .....	28
OPERATING THE BASE AND FOCUSING .....	29
OPERATING THE ILLUMINATION UNIT .....	30
ENDING PROCEDURE .....	32
<b>TROUBLESHOOTING</b>	
TROUBLESHOOTING GUIDE .....	33
<b>SPECIFICATIONS AND PERFORMANCE</b>	
SPECIFICATION AND PERFORMANCE .....	34
ELECTROMAGNETIC COMPATIBILITY .....	35

ELECTRIC RATING .....	35
SYSTEM CLASSIFICATION .....	35
PURPOSES OF USE .....	35
OPERATION PRINCIPLES .....	35
SYSTEM CONFIGURATION .....	36
SHAPE OF PLUG .....	37
SYMBOL .....	37

## **MAINTENANCE AND CHECKS**

PERIODIC MAINTENANCE .....	38
DAILY MAINTENANCE .....	38
ORDERING CONSUMABLES .....	38
REPLACING ILLUMINATION LAMPS .....	39
REPLACING FUSES .....	41
RESTOCKING CHINREST TISSUE .....	41
MAINTENANCE PROCEDURE .....	42
CLEANING REMOVABLE PARTS .....	42
CLEANING LENSES AND PRISMS .....	42
CLEANING THE SLIDING PLATE, RAIL AND WHEEL SHAFT .....	43
DISPOSING OF THE PRODUCT .....	43

## **OPTIONAL ACCESSORIES**

DIGITAL CAMERA UNIT DC-1 .....	44
STILL CAMERA ATTACHMENT SR-53 .....	44
BEAM SPLITTER .....	45
TV RELAY LENS .....	45
TV RELAY LENS TL-54 .....	46
TV RELAY LENS TL-55 .....	46
TV ATTACHMENT TL-56 .....	46
TV ATTACHMENT TL-57 .....	47
BACKGROUND ILLUMINATION BG2-GN .....	47
OBSERVATION TUBE .....	47
FIXATION TARGET .....	47
12.5X MEASURING EYEPIECE .....	48
20X EYEPIECE .....	48
APPLANATION TONOMETER .....	48
HRUBY LENS .....	48
PARALLEL BINOCULAR TUBE PB-2 .....	49
YELLOW FILTER UNIT .....	49
AUXILIARY SPRING SO-AS 0, 1, 2, 3 .....	49
PATIENT GRIP PG-1 .....	49
ADAPT COVER SO-AC3, 4, 5 .....	49

# CONFIGURATION

## NAMES OF MAIN BODY COMPONENTS

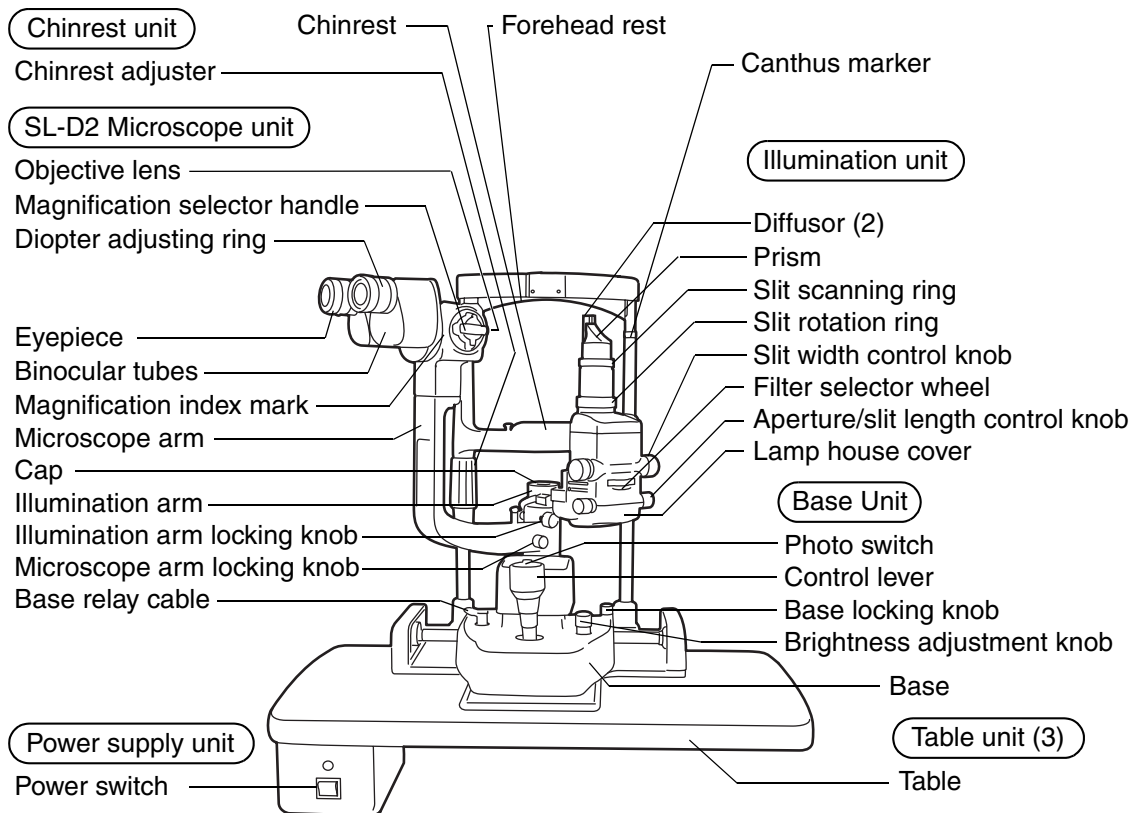

### **SL-D4 Microscope unit**

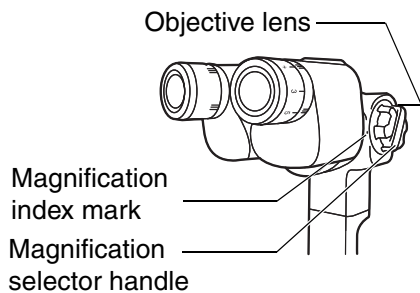



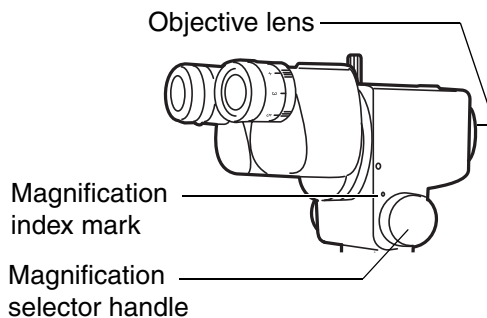

### **SL-D4Z Microscope unit**

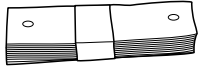

- A model without diffusor (2) is also available.
- A model without table unit (3) is also available.

## **STANDARD ACCESSORIES**

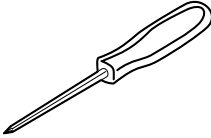
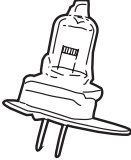
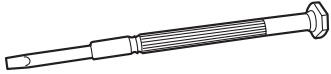
Make sure that all the following standard accessories are included.  
Figures in parentheses are the quantities.

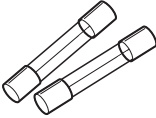
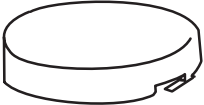
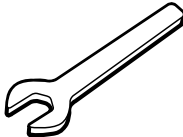
<p>Chinrest tissue (1)</p> 	<p>Dust cover (1)</p> 
<p>Test rod (1) (This is not always included with the standard specifications.)</p> 	<p>Crosshead screwdriver (1)</p> 
<p>Spare illumination lamp (1)</p> 	<p>Screwdriver (1)</p> 
<p>Spare socket (1)</p> 	<p>Spare fuse (2) (Quantity may differ, depending on the specification, or this item may not be included in standard accessories.)</p> 
<p>Cap (1)</p> 	<p>Spanner (1) (for instrument type table top only)</p> 

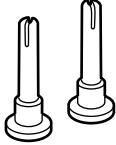
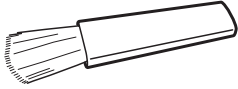
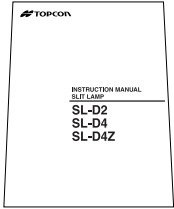
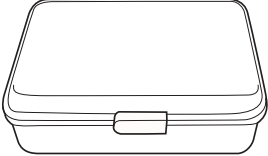
<p>Spare chinrest tissue pin (2)</p> 	<p>Cleaning brush (1)</p> 
<p>Instruction Manual (1)</p> 	<p>Accessory case (1) (This is not always included with the standard specifications.)</p> 

For optional accessories, see “Optional Accessories” on page 40.

# COMPONENTS

## COMPONENTS

(1) Illumination unit

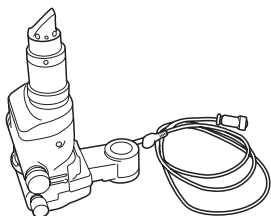

(2) Binocular tubes



(3) Base unit

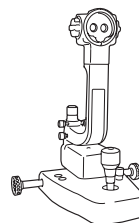

(4) Instrument type table top (w/power supply)\*

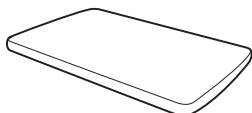

(4)' Unit type table top\*

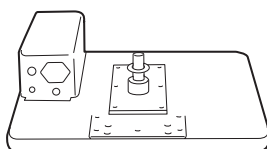

\* The illustration shows the SL-D2 type.

(5) Rail cover

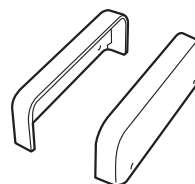

(6) Chinrest base unit\*

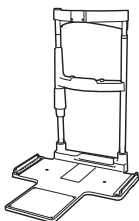

(7) Power cable



(8) Setscrew (for chinrest base unit)

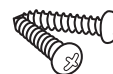

(9) Cable cover



(10) Cable cover fixing screw

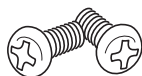

(11) Rail cover fixing screw



Article name	Qty	Article name	Qty
(1) Illumination unit	1	(6) Chinrest base unit	1
(2) Binocular tubes	1	(7) Power cable	1
(3) Base unit	1	(8) Setscrew (for chinrest base unit)	2
(4) Instrument type table top (w/power supply)*	1	(9) Cable cover	1
or (4)' Unit type table top	1	(10) Cable cover fixing screw	2
(5) Rail cover	2	(11) Rail cover fixing screw	4

\* (4) or (4)' table top is not included, depending on the specifications.

(6) Depending on the specifications, chinrest might not be included.

# ASSEMBLY PROCEDURE



## CAUTION

To prevent units from falling during use and movement, secure each unit.

## SECURING THE INSTRUMENT TYPE TABLE TOP

### SECURING ON AUTOMATIC INSTRUMENT TABLE AIT-20/AIT-15

- 1** Remove the cover of the instrument table. Remove the 3 screws of the cover (AIT-20 only: For details, refer to the instruction manual of AIT-20.)

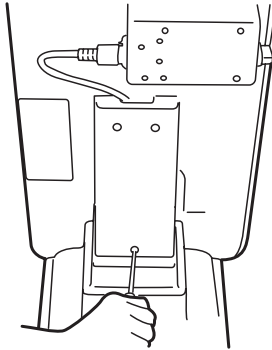

- 2** Place the tabletop on the instrument table, and fasten it with the 4 bolts attached to the instrument table. To reverse the direction of the instrument table, remove the power supply from the bottom of the table top and fit it on the opposite side.

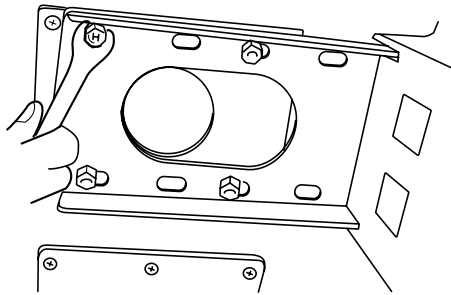

Connect the power cable to the table outlet and power supply of the instrument table. Place the excess cable inside the cover, and fasten the cover.



## **SECURING THE UNIT TYPE TABLE TOP**

- 1** Remove the plastic washer from the unit type table top; this washer is taped to the shaft assembly.
- 2** Insert the plastic washer and the shaft together into the cavity for the ophthalmic unit arm.

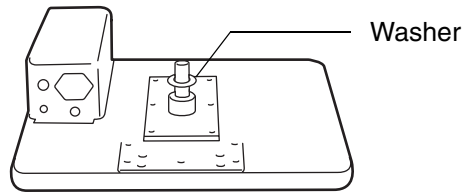

In the unit type table top, the power supply is fitted so that the ophthalmic unit is on the right-hand side. When attaching the ophthalmic unit on the left-hand side, remove the power supply and reattach it to the right-hand side (with 4 screws).

## **SECURING THE PATIENT GRIP PG-1 (OPTIONAL ACCESSORY)**

- 1** Align the patient grip with the groove in the back of the chinrest base unit.
- 2** Screw the patient grip on firmly.

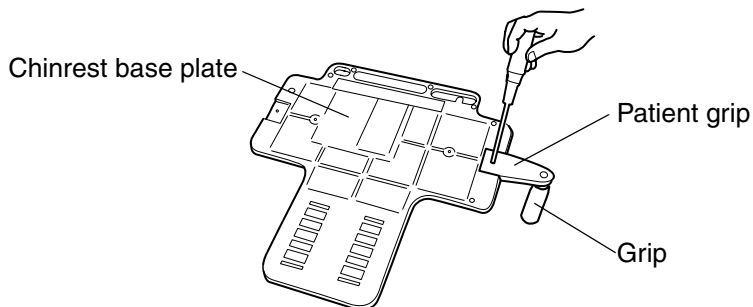

## **SECURING THE CHINREST BASE PLATE**

- 1** Secure the chinrest base plate to the unit type table top with 2 screws (8).

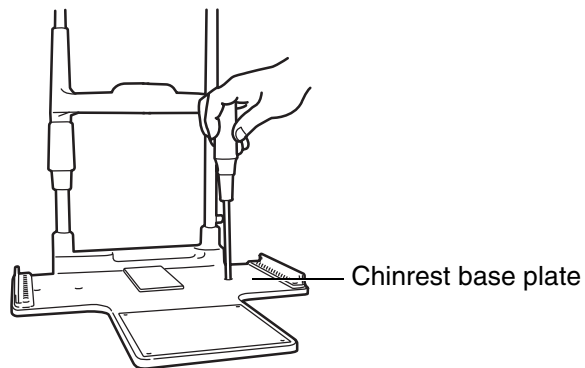

## **SECURING THE BASE UNIT AND RAIL COVER**

- 1** Align the wheel of the base unit with the rail of the chinrest base plate.
- 2** Fasten the rail covers with 4 screws (11): (2 screws each on the right and left sides).

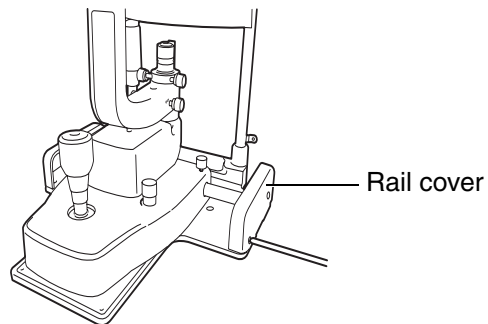

## **SECURING THE BINOCULAR TUBES**

- 1** Align the pin of the microscope unit with the groove on the binocular tubes, and fasten the fixing screw.



Make sure you do not touch the lens surfaces.

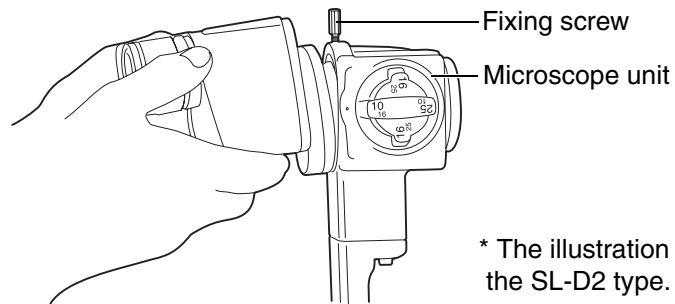

## **SECURING THE ILLUMINATION UNIT**

- 1** Loosen the microscope arm locking knob of the base unit. Manually turn the shaft and tilt the guide rod-shaft index 30-60°. Now refasten the microscope arm locking knob.

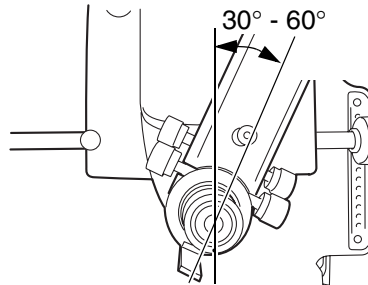

- 2** Loosen the fixing screw on the outside of the fitting cavity of the illumination unit with a screwdriver. Align indices and slowly lower the illumination unit on to the shaft of the base unit.

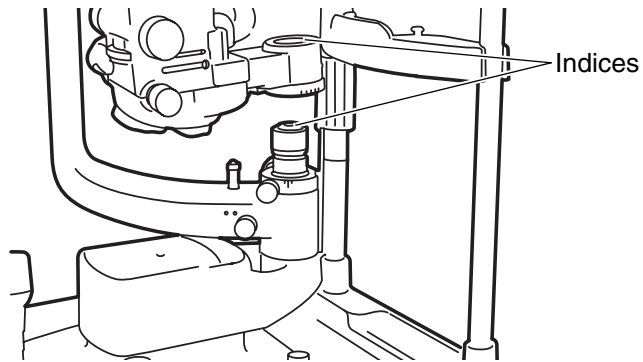

While assembling the illumination unit, take care not to get your fingers caught.

- 3** Firmly tighten the fixing screw with a screwdriver.

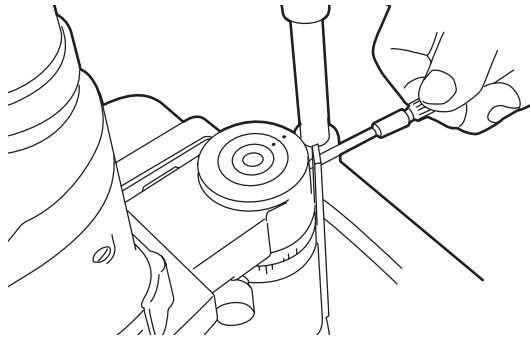

To allow smooth rotation of the illumination unit, make sure you do not fasten the screw too tightly.

## **CONNECTING AND SECURING CABLES**

- 1** Connect the cable of the illumination unit and the power cable to the power supply.

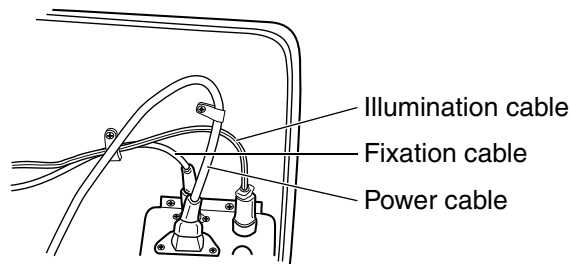

- 2** Pass the 5-pin connector of the metal plug connected to the power supply through the hole of the chinrest and connect it to the base unit.

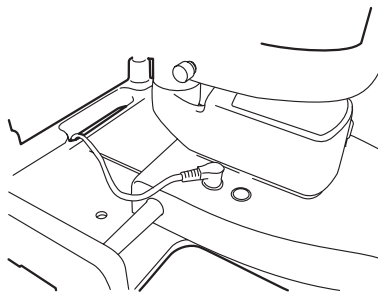

- 3** Fit the cable cover with 2 screws (10).

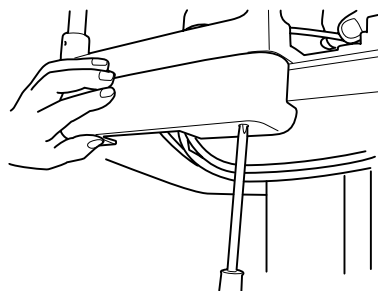

- 4** Pull the base unit toward the side of the operator, then lock it. Attach the cables to the back of the table with the cable clip.
- 5** Move the base unit and illumination unit, and make sure there is enough cable to allow free movement of the base unit in all directions.

## **FITTING THE CHINREST TISSUE**

- 1** Remove the chinrest tissue pins.
- 2** Take approximately one-fifth of the pad of chinrest tissues and secure this at each end with the pins.

## **FITTING THE CAP**

- 1** Fit the cap to the shaft, aligning the guide rod with the groove in the cap.

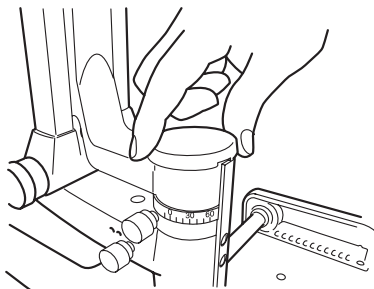

## **SECURING THE TONOMETER MOUNT (OPTIONAL ACCESSORY)**

SO-TM1 and SO-TM2 may be included in standard accessories, depending on the specifications.

### **SO-TM1**

- 1** Align the locating pins of SO-TM1 into the holes of the SL-D2/D4 microscope, and fasten the screw.

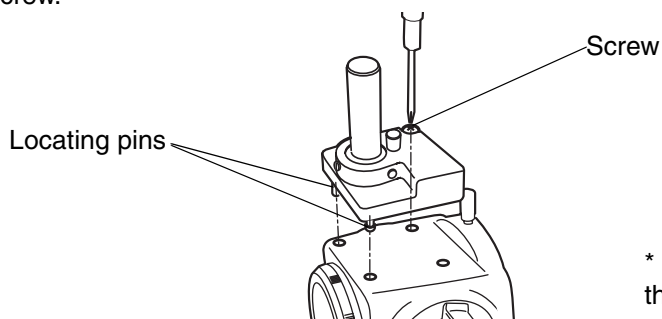

\* Illustration shows the SL-D2 type.

- 2** The applanation tonometer R900 type can be mounted on SO-TM1.

### **SO-TM2**

- 1** Align the locating pins of SO-TM2 into the holes of the SL-D2/D4 microscope, and fasten the fixing knob.

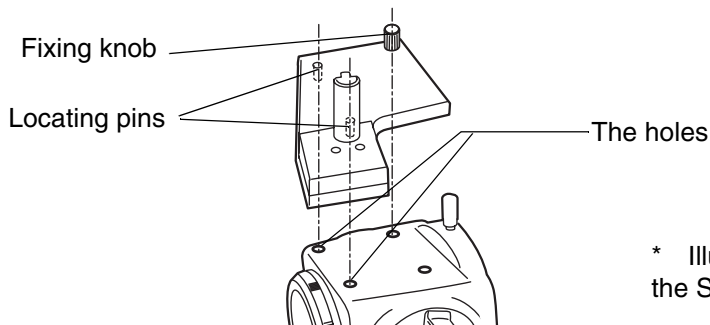

\* Illustration shows the SL-D2 type.

- 2** The applanation tonometer 870 type can be mounted on SO-TM2.

### SO-TM3

- 1** Align the locating pins of SO-TM3 into the holes of the SL-D4Z microscope, and fasten the two screws.

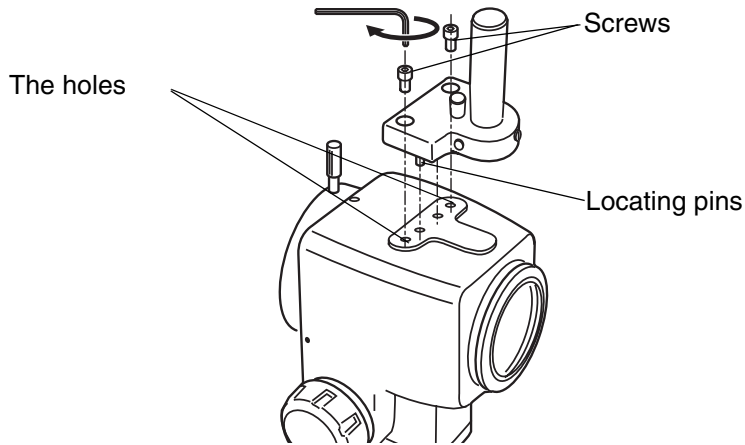

- 2** The applanation tonometer R900 type can be mounted on SO-TM3.

### SO-TM4

- 1** Align the locating pins of SO-TM4 into the holes of the SL-D4Z microscope, and fasten the two screws.

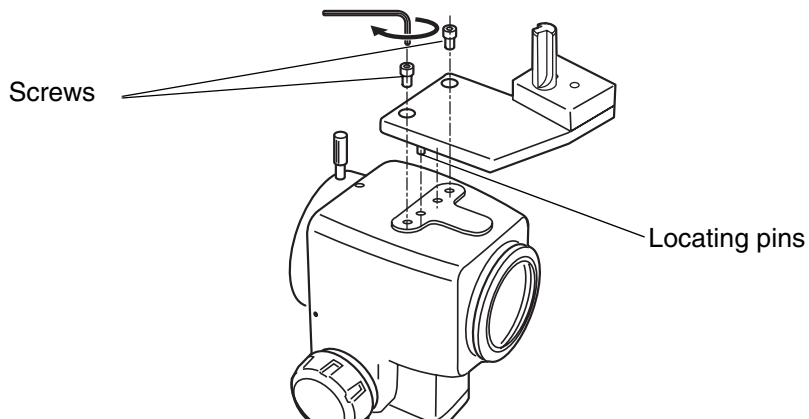

- 2** The applanation tonometer 870 type can be mounted on SO-TM4.

## **COUNTER-BALANCING THE VERTICAL MOVEMENT**

When you fit accessories, including the photography unit, to the main body, you may need to adjust the vertical counter-balance movement. To do this, auxiliary springs must be fitted.

Major Combinations of Accessories and Necessary Auxiliary Springs

Accessories	Necessary auxiliary spring	
	Without tonometer	With tonometer
TV relay lens TL-55 + SONY DXC-33 (DXC-390)	None	Auxiliary spring SO-AS0
TV attachment TL-56 + Nikon Microsystem		
Digital camera unit DC-1		
TV relay lens TL-54 + JVC KY-F70	Auxiliary spring SO-AS0	Auxiliary spring SO-AS0
Beam splitter + Observation tube		Auxiliary spring SO-AS1
Camera attachment SR-53 + NIKON mount + FUJI FINEPIX S2 Pro		Auxiliary spring SO-AS2
Beam splitter + TV relay lens (1/2C) + JVC KY-F70		

Each auxiliary spring consists of 2 identical springs.  
Do not use different springs together in one set.

### **COUNTER-BALANCE PROCEDURE**

- 1** Turn the control lever clockwise and raise the base to the top position, remove the centre screw and take off the cover.

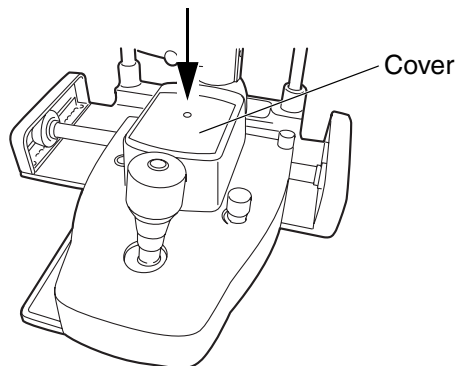



- 2** Insert the auxiliary spring unit vertically into the auxiliary spring port, with the flange face turned upwards. (Make sure that the spring is inserted into the groove in the bottom of the port.)

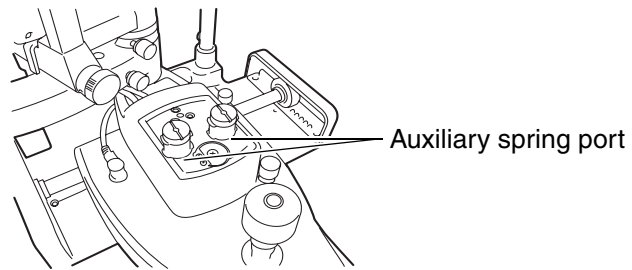

- 3** Open the auxiliary spring unit with the auxiliary spring port, and lightly push the spring till it stops. (You can use a large screwdriver, a flat sheet metal tool, a coin or something similar to do this.)
- 4** With the auxiliary spring unit lightly touching the stopper, turn about  $90^\circ$  (in either direction), then release. The auxiliary spring locks into the positioning groove and assembly is complete. (To remove the auxiliary spring, lightly press it down to the stopper, rotate it  $90^\circ$  and remove from the port.)

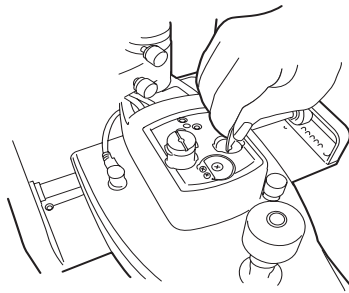

# PREPARATIONS

## POWERING ON

- 1** Connect the power cable.
- 2** Turn the POWER switch ON.

## ADJUSTING THE DIOPTER AND PUPILLARY DISTANCE (PD)

<b>NOTICE</b>	To ensure sharp observation of slit images, always carry out the diopter and eye width adjustment.
---------------	--

If no test rod is provided, turn the diopter adjusting ring to set the diopter scale to your diopter.

- 1** Insert the test rod into the rotation shaft cavity, and set the black face square with the microscope.

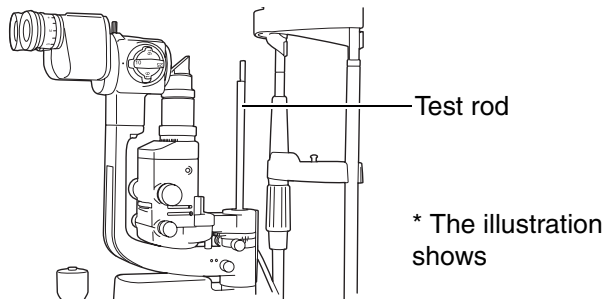

- 2** Turn the POWER switch ON and turn the brightness adjustment knob to an intermediate position.
- 3** Adjust the illumination to  $\phi$  10mm by adjusting the slit adjustment knob and aperture/slit length selector knob.
- 4** Turn the diopter adjusting ring of the eyepiece counter-clockwise to the end.
- 5** Turn the diopter adjusting ring clockwise and stop when you can clearly see the test rod.
- 6** Read the value on the diopter scale of the stop position. The value shows the diopter (D).
- 7** Repeat diopter adjustment for the eyepiece on the other side in the same way.
- 8** After adjusting the diopter, turn the slit adjustment knob until the slit width is about 1mm, then check if you can see the slit image projected on the test rod clearly.

- 9** While holding the prism box, look through the eyepiece with both eyes, and adjust the eye width so that the image projected on the test rod comes together and looks three-dimensional.

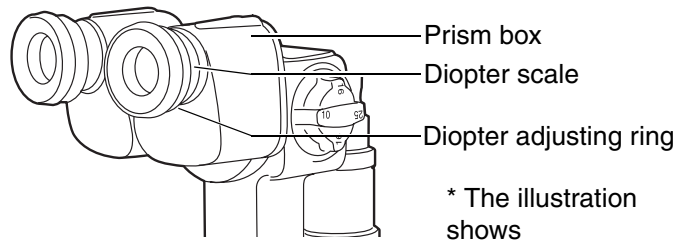

The eyepiece with scale may be included in the components, depending on the specifications.

- 1** Insert the test rod into the rotation shaft cavity, and set the black face square with the microscope.

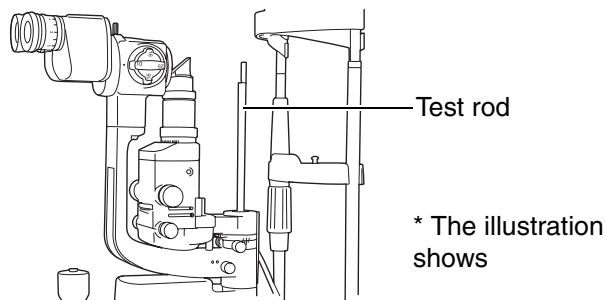

- 2** Set the eyepiece with scale to the non-dominant eye side.
- 3** Turn the POWER switch ON and turn the brightness adjustment knob to an intermediate position.
- 4** Adjust the illumination to  $\phi$  10mm by adjusting the slit adjustment knob and aperture/slit length selector knob.
- 5** Turn the diopter adjusting ring of the eyepiece with scale ( $\ominus$ ) fully counter-clockwise.
- 6** Turn the diopter adjusting ring clockwise and stop when you can clearly see both the scale ( $\oplus$ ) and the test rod.
- 7** Read the value on the diopter scale of the stop position. The value shows the diopter (D).
- 8** Set the diopter scale of the other eyepiece to the value read.
- 9** Set the eyepiece with scale ( $\oplus$ ) to the dominant eye side, and adjust the diopter scale of the dominant eye as in steps 5 and 6.
- 10** After adjusting the diopter, turn the slit adjustment knob until the slit width is about 1mm, then check if the slit image projected on the test rod can be clearly seen with both right and left eyes.

- 11** Holding the prism box, look through the eyepiece with both eyes, and adjust the pupillary distance so that the image projected on the test rod can be seen without diplopia (double vision), and appears to be three dimensional.

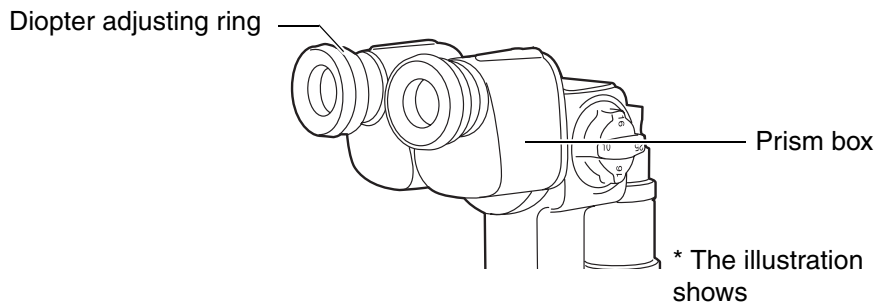

# OPERATION PROCEDURES

## FIXING THE PATIENT'S FACE AND FIXATION

- 1** Place the patient's chin on the chinrest with his forehead against the forehead rest.
- 2** Rotate the chinrest adjuster to align the patient's eye with the canthus marker on the chinrest frame.

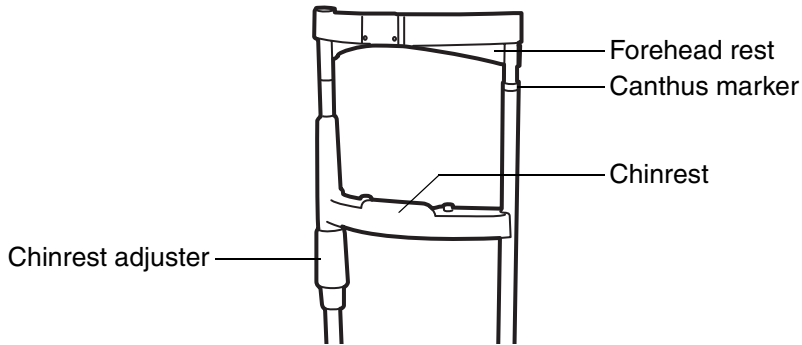

## OPERATING THE MICROSCOPE UNIT

Turn the magnification selector handle and set a magnification mark to the magnification index mark.

### SL-D2

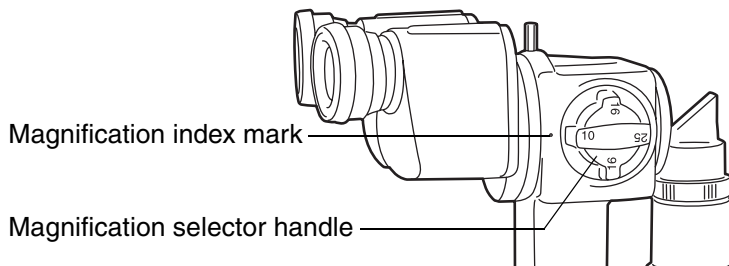

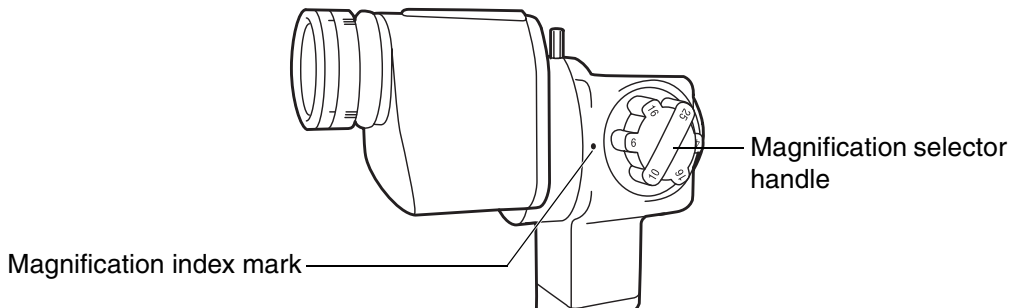

### SL-D4

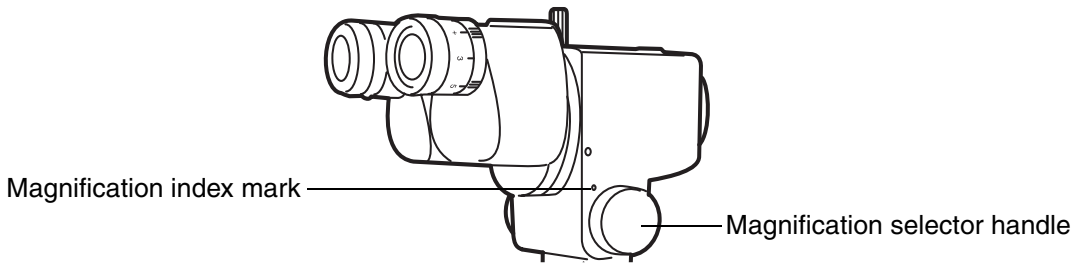



For the overall magnification in conjunction with the magnification marks of the magnification selector handle, see page 46.

### **OPERATING THE BASE AND FOCUSING**

 <b>CAUTION</b>	To avoid injury to the patient's eye and nose, pay particular attention while operating the instrument body.
 <b>CAUTION</b>	To prevent fingers from being caught between moving parts, beware of the moving parts while operating the main body.
<b>NOTICE</b>	Do not loosen the base locking knob excessively, as this may cause it to fall from the base.

- 1** For major horizontal movements, hold the control lever in the upright position and move the entire base.
- 2** For fine adjustments, move the control lever in the required direction.
- 3** Turn the control lever clockwise to raise the base and turn it counter-clockwise to lower the base.

**4** Fasten the base locking knob to fix the base.

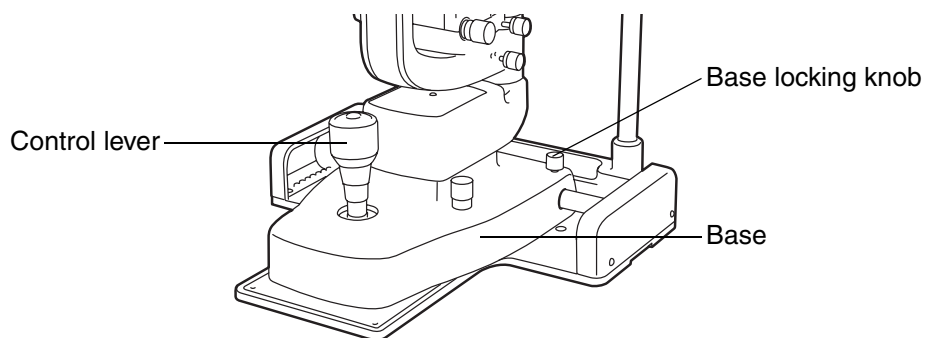

- Rough focusing is carried out with major movements, following steps 1 to 3.
- Fine focusing is done with the microscope, following steps 2 and 3 above.

## **OPERATING THE ILLUMINATION UNIT**

 <b>CAUTION</b>	To avoid causing the patient pain and damage to the patient's eye, do not make the illumination too bright.
<b>NOTICE</b>	<ul style="list-style-type: none"><li>• Adjust the slit width appropriately for the purpose of observation.</li><li>• Use the slit width scale as a guideline.</li><li>• When using the square mirror, incline the illumination unit at least 10°.</li></ul>

### **ADJUSTING THE BRIGHTNESS**

Turn the brightness adjustment knob.

You can adjust the brightness of the illumination light to your preferred illumination setting.

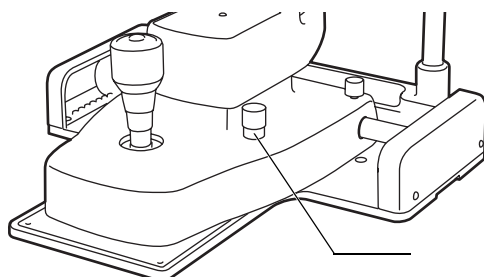

### ADJUSTING THE SLIT WIDTH

Turn the slit width control knob.

The slit width can be changed gradually between 0 and 14mm (14mm = circle).

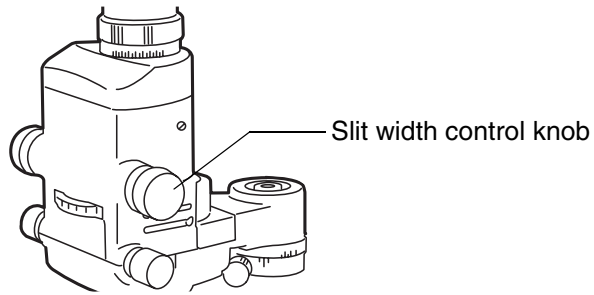

### CHANGING THE APERTURE/SLIT LENGTH

Turn the aperture/slit length selector knob.

When the slit is fully opened, 5 types of spot illumination ( $\phi 14$ ,  $\phi 10$ ,  $\phi 5$ ,  $\phi 1$ ,  $\phi 0.3\text{mm}$ ) are available.

The slit length can be changed gradually between 0 and 14mm.

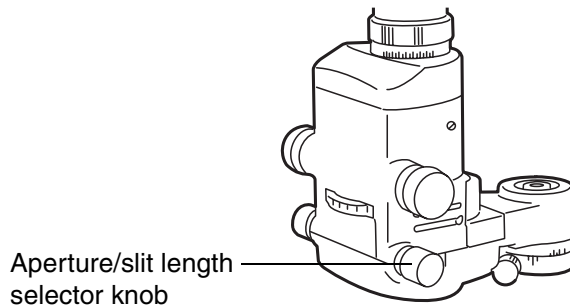

### TURNING THE SLIT

Turn the slit rotation ring.

You can change the slit image from vertical to horizontal. In this mode, you can read the slit angle off the angle scale.

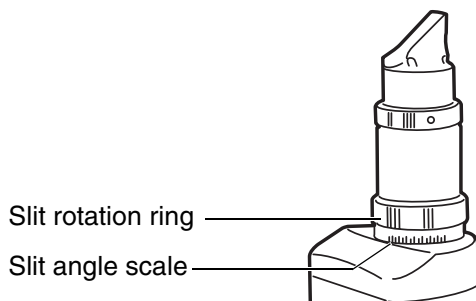



## SWINGING THE SLIT SIDEWAYS

Turn the slit scanning ring and swing the illumination to the right and to the left.  
This provides indirect illumination, displacing the slit light from the microscope centre.



This function is used for scanning observation and observation with indirect illumination.

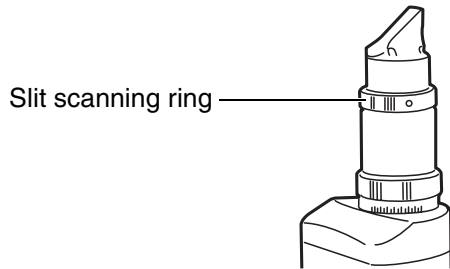

## CHANGING FILTERS

Turn the filter selector wheel and select the desired filter from the 4 types.

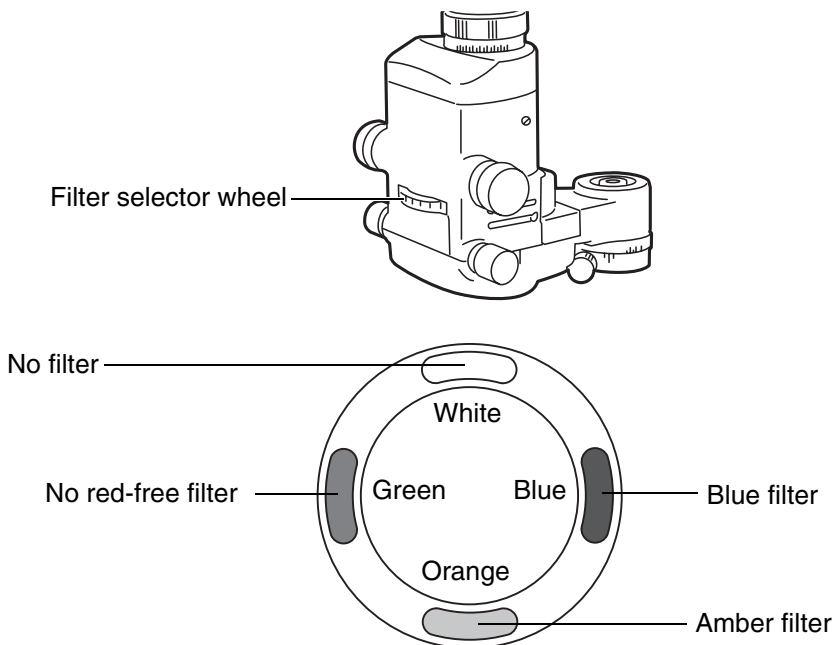

The amber filter is used to make the eye ground clearly visible.

## ENDING PROCEDURE

Turn the Power switch OFF.

# MAINTENANCE AND CHECKS

## PERIODIC MAINTENANCE

Before using, check the following:

- Adjust the diopter and eye width according to “Adjusting the Diopter and Pupillary Distance (PD)” on page 25, turn the slit adjustment knob and make the slit width about 1mm: The slit image projected on the test rod is seen clearly.
- Move the base backwards and forwards and from right to left: The base moves smoothly.
- Component parts, including the eyepiece unit, are fitted in place.
- The chinrest base is fitted securely to the table.
- Cables and plugs are connected firmly.

## DAILY MAINTENANCE



- Dust can affect this instrument adversely. Put the dust cover over it when you are not using it.

## ORDERING CONSUMABLES

- When you order consumable items, contact your dealer or TOPCON (see the back cover) and specify the article name, product code and quantity.

Article name	Product code
Illumination lamp (D display is printed on a flange.)	447402040
Socket	408212010
Chinrest tissue	403104082
Fuse T-1A, 250V (Bel Fuse, Part No. 5TT1): 100-120V	446356003
Fuse T-0.75A, 250V (Bel Fuse, Part No. 5TT750): 220-240V	447706351

## REPLACING ILLUMINATION LAMPS

 <b>CAUTION</b>	When replacing the lamp, switch off the power supply and remove the power cable to avoid electric shocks.
 <b>CAUTION</b>	If you replace the lamp immediately after switching it off, beware of high temperatures: they could cause burns.
<b>NOTICE</b>	To ensure perfect illumination, make sure that the socket flange and notch are fitted firmly.
<b>NOTICE</b>	Use a soft cloth and do not touch the illumination lamp with bare fingers. Clinging fingerprints and stains may affect illumination.

- 1** Turn the Power switch OFF.
- 2** Hold the lamp housing cover at the arrow position on both sides, pull it downward and remove.

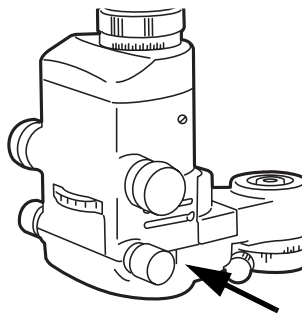

- 3** Pull the socket fixing lever lightly and turn it counter-clockwise.

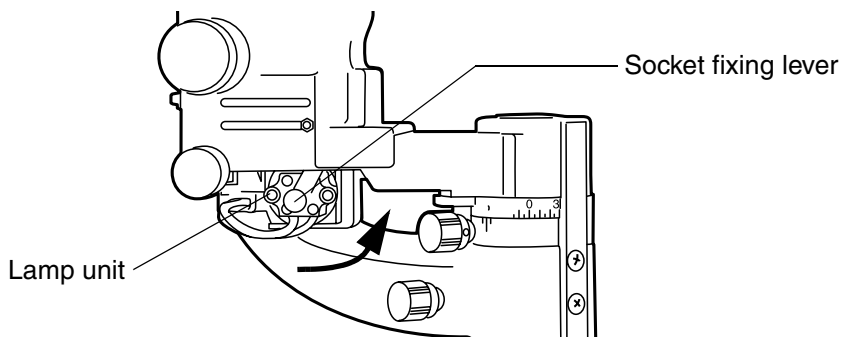

- 4** Pull off the socket plug.

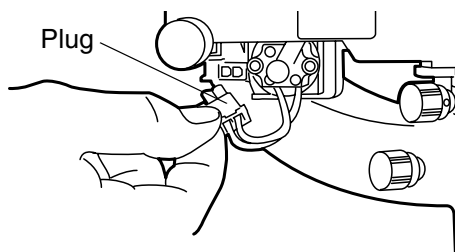

- 5** Pull out the lamp unit.

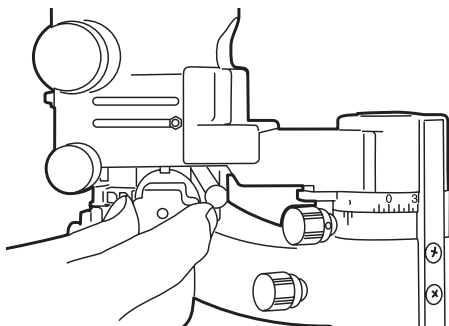

- 6** Pull out the illumination lamp from the socket and replace a new lamp in the socket: Take note of the socket direction.

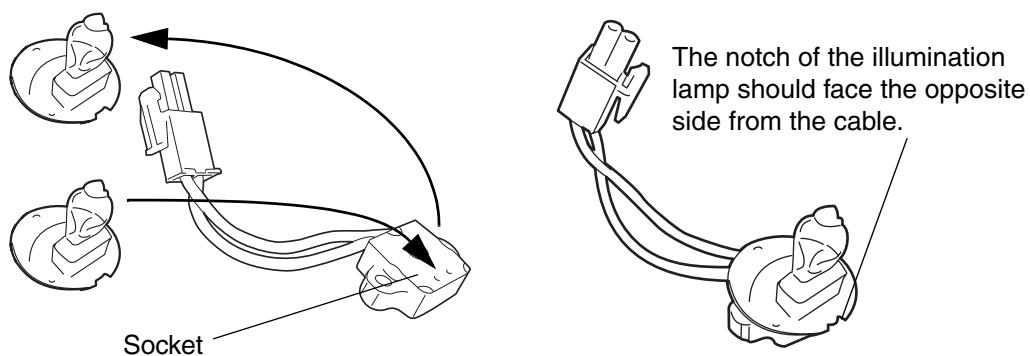

- 7** Install the lamp unit and lamp house cover in reverse order.

## REPLACING SOCKETS

<b>NOTICE</b>	The socket may deteriorate due to the constant heat: it should therefore be replaced after the lamps have been changed two or three times.
---------------	--

- 1** Remove the lamp following steps 1 to 4 of “Replacing Illumination Lamps”.
- 2** Replace the socket with a new one.
- 3** Install the lamp unit and lamp house cover in reverse order.

## REPLACING FUSES

 <b>CAUTION</b>	When replacing fuses, first switch off the power supply and remove the power cable to avoid electric shocks.
--	--

<b>NOTICE</b>	Use the glass tube fuse with the rating as stated on the side of the fuse holder.
---------------	---

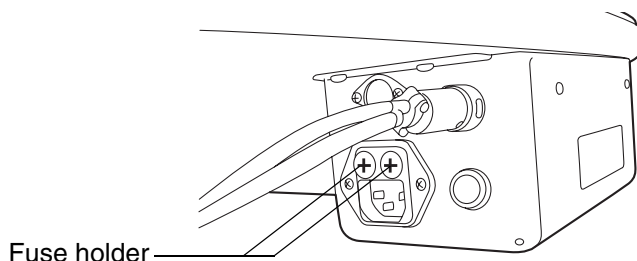

- 1** Turn the Power switch OFF and remove the power cable from the AC power source.
- 2** Pry the fuse holder lid with a crosshead screwdriver. The fuse comes out.
- 3** Replace the fuse with a new factory-authorized fuse.
- 4** Reinstall the fuse holder in reverse order.



## RESTOCKING CHINREST TISSUE

When the supply of chinrest tissue runs out, remove the chinrest tissue pins and replace the tissue.

## **MAINTENANCE PROCEDURE**

 <b>CAUTION</b>	Before carrying out daily maintenance, remove the power cable (to avoid electric shocks) and wait until the body has cooled down (to avoid burns).
 <b>CAUTION</b>	To prevent burns, do not touch parts inside the lamp cover house during operation and immediately after switching off the power supply.
<b>NOTICE</b>	To prevent discoloration and deterioration in the chinrest, forehead rest and other plastic parts, do not use volatile solvents for cleaning, such as benzine, thinner, ether or gasoline. Wipe parts with a cloth moistened with a tepid solution of neutral kitchen detergent.

### **CLEANING REMOVABLE PARTS**

Wipe the forehead rest, the chinrest and the patient grip (if a pair of patient grips is used) with a cloth moistened with a tepid solution of neutral kitchen detergent.

### **CLEANING LENSES AND PRISMS**

#### **REMOVING STAINS**

<b>NOTICE</b>	To avoid damaging lens surfaces, do not use tweezers or similar equipment to hold the gauze.
---------------	--

- 1** Prepare a solution of ethyl alcohol 20% and ether 80%.
- 2** Remove dust from the lens and prism surfaces with the attached cleaning brush, or a blower.
- 3** Using clean gauze, lightly draw a spiral from the lens/prism centre outward.
- 4** If the stain remains, repeat this 2 to 3 times.
- 5** If stains are persistent, call your dealer or TOPCON (see the back cover).

## CLEANING THE SLIDING PLATE, RAIL AND WHEEL SHAFT

<b>NOTICE</b>	When stained, the sliding plate and rail of the table top and the wheel shaft of the base move less smoothly. Clean them with a dry cloth.
---------------	--

- 1** Wipe the wheel shaft clean by moving the base to the right and to the left.
- 2** Raise the control lever and wipe the sliding plate clean.

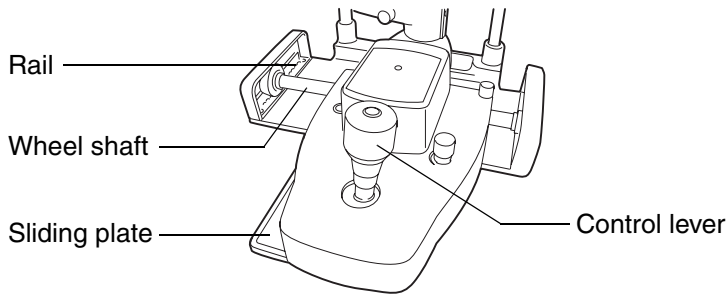

## DISPOSING OF THE PRODUCT

 <b>CAUTION</b>	The base contains strong springs. Do not attempt to disassemble or burn the base, as the springs could cause injury by shooting out of it.
--	--

For disposal of the instrument and consumables, contact a waste disposer or call your dealer or TOPCON (see the back cover).

# TROUBLESHOOTING

## TROUBLESHOOTING GUIDE

 <b>CAUTION</b>	<p>To avoid electric shocks, do not attempt overhauling, rebuilding or repairs. Contact your dealer for repairs.</p>
--	--

If you suspect a problem, use the check list below to check the possible cause.  
 If the check list below does not solve the problem, or if the problem is not included in the list, contact your dealer or TOPCON (see the back cover).

### Check List

Problem	Typical condition	Check	Page
Illumination lamp does not work	Power switch is OFF.	Turn Power switch ON.	25
	Cable connection is disconnected.	Connect the cable.	20
	Base relay cable is switched off.	Connect the cable.	20
	Brightness adjustment knob is at the minimum setting.	Turn up brightness selector knob.	30
	Illumination lamp is broken.	Replace it with a new illumination lamp.	34
	Socket is off.	Insert the socket.	34
	Socket has deteriorated.	Replace it with a new socket.	36
Illumination field is not uniform/is shady/is dark	Aperture/slit length selector knob is not fastened.	Click the aperture/slit length selector knob into a fixed position.	31
	Filter selector lever is not clicked.	Click the filter selector lever in place.	32
	Illumination lamp is not fitted in place.	Fit the illumination lamp in the socket.	34
Fuse blows	Rated capacity of fuse is incorrect.	Use an approved fuse with the correct rating.	33, 36
Fixation target (optional) does not work	The plug above chinrest is off.	Insert the plug.	—
	Fixation cable is off	Insert the cable.	20



# OPTIONAL ACCESSORIES

TOPCON Slit Lamp SL-D2/SL-D4/SL-D4Z has the following optional accessories.  
For enquiries, please contact your dealer or TOPCON (see the back cover).



## CAUTION

To prevent items from falling during use and movement, attach optional accessories securely.

- For details, please refer to the instruction manual of each product.

## DIGITAL CAMERA UNIT DC-1

### FEATURES

- A digital camera combined with a slit lamp.
- Cables are wired inside the arm and do not interfere with instrument operation.
- Recordable with Compact flash card.
- Connectable with the IMAGEnet

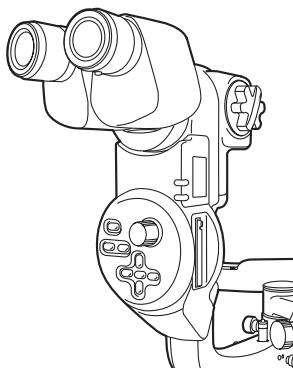

## STILL CAMERA ATTACHMENT SR-53

### FEATURES

- Can be connected to a marketed camera for easy photography.
- The beam splitter division ratio is TV 50%: patient 50%.

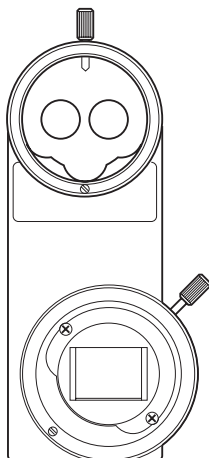

## CONNECTABLE CAMERA

Recommendation	Size of camera's light receiving unit	Shape of camera mount	Attachment & TV relay lens	
FUJI FINEPIX S-Pro Series	APS-C size	NIKON F mount	Still camera attachment SR-53	Adapter SO-CMNF for NIKON F

## BEAM SPLITTER

### FEATURES

- Used to attach the TV relay lens T-53 (w/ beam splitter type) and observation tube.
- The TV relay lens and observation tube can be attached to either side.
- The beam splitter division ratio is TV 50%: patient 50%.

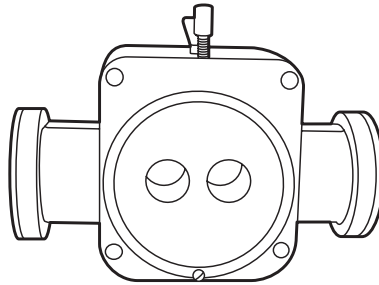

## TV RELAY LENS

- Three types of TV relay lens have been prepared for use with different TV camera types (C mount 1/2 type, C mount 1/3 type and bayonet mount 1/2 type for Sony).

### FEATURES

- Used with the beam splitter.
- Can connect a TV camera to carry out monitor observation and photograph still images.



## **TV RELAY LENS TL-54**

## **TV RELAY LENS TL-55**

- The type of TV relay lens depends on the type of TV camera to be used.  
For C mount 1/2 type TV camera: TL-54  
For C mount 1/3 type TV camera: TL-55

### **FEATURES**

- Incorporated with the beam splitter.
- Can connect a TV camera to carry out monitoring observation and photograph still images.
- The beam splitter can be switched IN and OUT.
- The beam splitter division ratio is TV 50%: patient 50%.

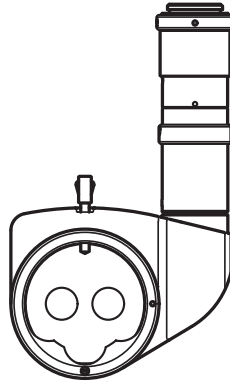

## **TV ATTACHMENT TL-56**

### **FEATURES**

- Used to connect the NIKON COOLPIX series (Micro System series).
- Combined with beam splitter.
- The beam splitter division ratio is TV 50%: patient 50%.

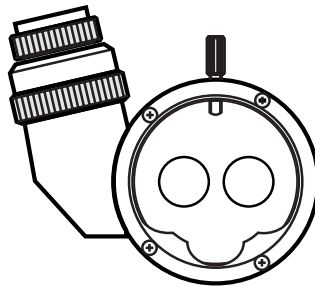

## **TV ATTACHMENT TL-57**

- Used to connect PANASONIC GP-KS162.
- Combined with beam splitter.
- The beam splitter division ratio is TV 50%: patient 50%.

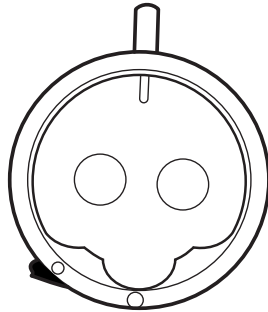

## **BACKGROUND ILLUMINATION BG2-GN**

### **FEATURES**

- Used for background illumination with LED light source.
- Power is supplied from the slit lamp power supply.
- Light intensity can be adjusted.

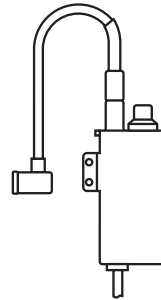

## **OBSERVATION TUBE**

### **FEATURES**

- Used in combination with beam splitter.
- Used for observation together with the inspector.
- Can be inclined to facilitate observation and can prevent the main body from falling.

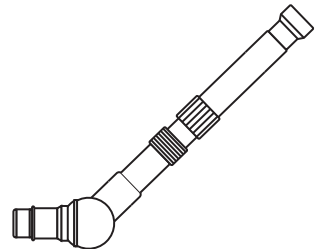

## **FIXATION TARGET**

### **FEATURES**

- Attached to the upper part of the chinrest to guide and fixate the patient's visual line easily.

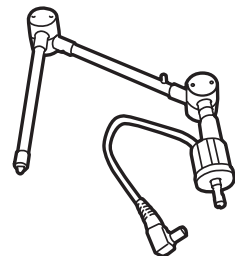

## **12.5X MEASURING EYEPIECE**

### **FEATURES**

- Replaces the normal eyepiece for measuring dimensions and angles.

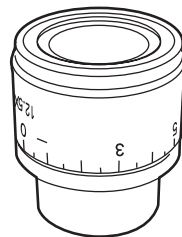

## **20X EYEPIECE**

### **FEATURES**

- Replaces the normal eyepiece for high magnification observation.

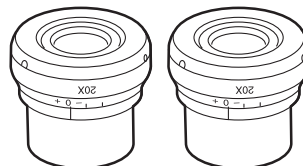

## **APPLANATION TONOMETER**

### **FEATURES**

- For measuring the intraocular pressure, models R900 type and T900 type, Haag-Streit, are available.

- \* The Topcon tonometer mount is required to enable use of the applanation tonometer, as follows:

APPLANATION TONOMETER	SLIT LAMP	TONOMETER MOUNT
R900 type	SL-D2/D4	SO-TM1
	SL-D4Z	SO-TM3
T900 type	SL-D2/D4/D4Z	TONOMETER GUIDE PLATE
870 type	SL-D2/D4	SO-TM2
	SL-D4Z	SO-TM4

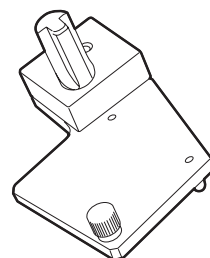
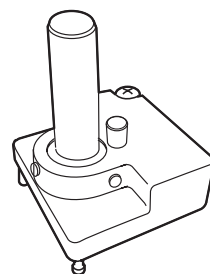

## **HRUBY LENS**

Normally, observation is possible only up to the anterior vitreous body due to the refractive power of the cornea and lens. With the Hruby lens, the posterior vitreous body and eye ground can also be observed.

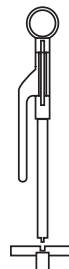

## **PARALLEL BINOCULAR TUBE PB-2**

### **FEATURES**

- Can observe a parallel view of the object.

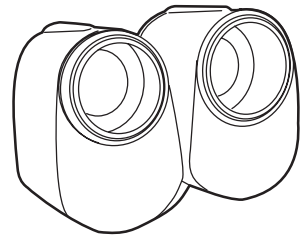

## **YELLOW FILTER UNIT**

### **FEATURES**

- Combines with the blue filter prepared in the main body for a high-contrast fluorescence observation.
- Easy filter insertion and removal.

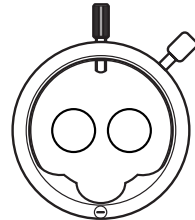

## **AUXILIARY SPRING SO-AS 0, 1, 2, 3**

### **FEATURES**

- Used to counterbalance vertical movement when you attach accessories such as a TV relay lens.

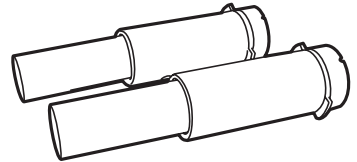

## **PATIENT GRIP PG-1**

### **FEATURES**

- A grip for patients to hold for comfort during diagnosis and photographing.
- Can be attached to the chinrest base.

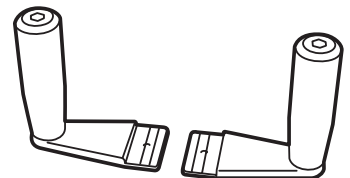

## **ADAPT COVER SO-AC3, 4, 5**

### **FEATURES**

This is used to cover gaps with the microscope arm and hide cables when you attach accessories such as the digital camera unit DC-1 and the still camera attachment SR-53.

SO-AC3: For SL-D4Z + DC-1/SR-53

SO-AC4: For SL-D2/D4 + DC-1/SR-53 + yellow filter unit

SO-AC5: For SL-D4Z + DC-1/SR-53 + yellow filter unit

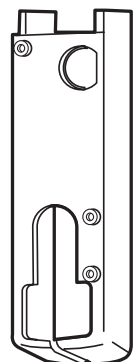

# SPECIFICATIONS AND PERFORMANCE

## SPECIFICATION AND PERFORMANCE

	SL-D2	SL-D4	SL-D4Z
Microscope unit			
Type	Galileo type		
Magnification	Drum, 3-step magnification	Drum, 5-step magnification	Manual zoom
Magnification steps	10, 16, 25	6, 10, 16, 25, 40	10, 16 and 25 w/clicks
Overall magnification (actual vision field)	10.00 (φ22.5mm)/ 15.98 (φ14.1mm)/ 25.53 (φ8.8mm)/	6.37 (φ35.1mm)/ 9.94 (φ22.5mm)/ 15.87 (φ14.1mm)/ 25.37 (φ8.8mm)/ 39.62 (φ5.6mm)/	6.35 - 31.75 (φ35.2 - φ7mm) *10x, 16x and 25x w/click
Eyepiece lens	Magnification:12.5x		
	Diopter adjustment range:-5D - +3D		-5D - +5D
Binocular tubes	PD adjustment: 55 - 78mm		
Illumination unit			
Illumination field	Slit width:0-14mm, can be altered gradually (14mm = circle) Slit length:1-14mm, can be altered gradually (14mm = circle) Aperture diameter:φ14, 10, 5, 1, 0.3		
Slit direction	Can be altered gradually from vertical to horizontal Side swing		
Filter	Blue filter, red-free filter, colour conversion filter, UV cut filter (normal use), IR cut filter (normal use)		
Illumination lamp	6V, 20W halogen lamp		
Base unit			
Forward-backward movement	90mm		
Right-left movement	100mm		
Vertical movement	30mm		
Fine movement forward-backward/right-left	12mm		
Chinrest unit			
Vertical movement	80mm		
Dimensions, Weight			
Dimensions: w/Table	550mm(W)x399mm(D)x558mm(H)		
w/Unit table	440mm(W)x379mm(D)x558mm(H)		
w/o Table and Chinrest	329mm(W)x306mm(D)x415-445mm(H)		
Weight: w/Table	17kg		17.5kg
	w/Unit table		16kg
	w/o Table and Chinrest		9.5kg
Table size	550mmx370mm		
Unit Table size	440mmx350mm		
Height from the table top to patient's eye	375mm		

The specification and design of the product can be altered for improvements without prior notice.

## **ELECTROMAGNETIC COMPATIBILITY**

This product conforms to the EMC standard (IEC60601-1-2:2001).

## **ELECTRIC RATING**

Source voltage: 100-120V, 220-240V AC, 50/60Hz

Power input: 160VA

## **SYSTEM CLASSIFICATION**

- Type of protection against electric shocks: Type B applied part  
Type B applied part is the applied part complying with the specified requirements of the Standard IEC 60601-1 to provide protection against electric shock, particularly regarding allowable LEAKAGE CURRENT.
- Type of protection against electric shocks: Class I equipment.  
Class I equipment does not depend on basic insulation only for protection against electric shocks. It can also be earthed; therefore, the metal parts with which one comes into contact do not become conductive if the basic insulation fails.
- The mode of operation: continuous operation equipment.
- Degree of protection against ingress of water: IP x0  
SL-D2, SL-D4 and SL-D4Z are the ordinary instruments (enclosed instrument without protection against ingress of water).
- Methods of sterilization or disinfection recommended by the manufacturer: SL-D2, SL-D4 and SL-D4Z do not have any part to be sterilized or disinfected.
- Not AP or APG equipment.

## **PURPOSES OF USE**

This slit lamp is used for enlargement in the observation of eyeballs and other parts.

## **OPERATION PRINCIPLES**

Illuminates the observed part by the illumination light emitted from the illumination optical system and allows enlargement observation by binocular stereoscopic microscope.



# SYSTEM CONFIGURATION



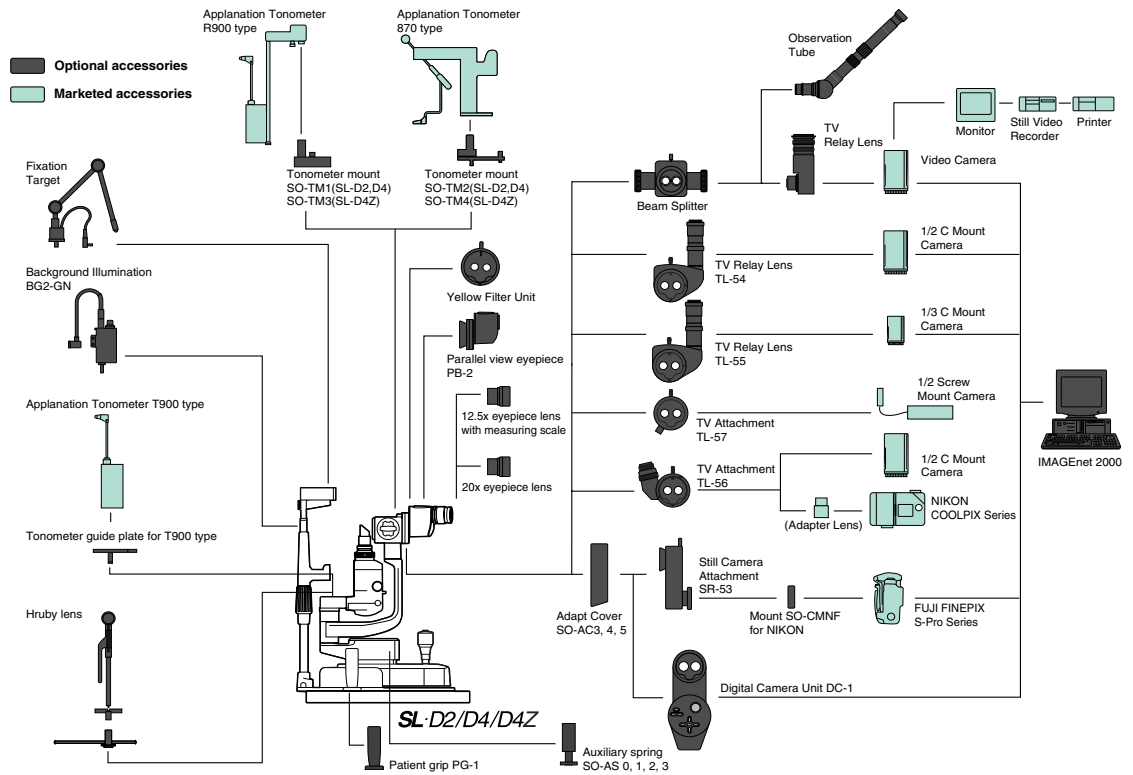

## SL-D2/SL-D4/SL-D4Z System Chart



## SHAPE OF PLUG

Country	Voltage/frequency	Shape of plug
Mexico	110V/50Hz	Type C&E
Argentina	220V/60Hz	Type A
Peru	220V/60Hz	Type A
Venezuela	110V/50Hz	Type C&E
Bolivia & Paraguay	220V/60Hz	Type A (Most common) Type H (Infrequently)
Chile	220V/60Hz	Type A
Colombia	110V/50Hz	Type C
Brazil	220V/60Hz 127V/60Hz	Type A Type C
Ecuador	110V/50Hz	Type C&E

## SYMBOL

Symbol	IEC Publication	Description	Description (French)
	60417-5032	Alternation Current	Courant alternatif
	60348	Attention, consult accompanying documents	Attention, consulter les documents d'accompagnement
	60417-5008	Off (power: disconnection from the mains)	Éteint (courant: coupure avec le secteur)
	60417-5007	On (power: connection of the mains)	Allumé (courant: raccordement sur le secteur)
	60878-02-02	Type B applied part	Classe B

---

When you contact us, please have the following information about your unit at hand:  
¥Machine type: SL-D2, SL-D4, SL-D4Z  
¥Manufacturing No. (Displayed on the rating plate on the left of the base.)  
¥Period of Usage (i.e. the purchase date).  
¥Description of Problem (as detailed as possible).

---

SLIT LAMP SL-D2, SL-D4, SL-D4Z

INSTRUCTION MANUAL  
The 2004 version (2004.03-100TH0)  
Date of issue: 5th February, 2004

Published by TOPCON CORPORATION

75-1 Hasunuma-cho, Itabashi-ku, Tokyo, 174-8580 Japan.

SLIT LAMP

---

# SL-D2

# SL-D4

# SL-D4Z

---

## TOPCON MEDICAL SYSTEMS, INC

37 West Century Road, Paramus, New Jersey 07652, U.S.A. Phone: 201-261-9450 Fax: 201-387-2710 www.topcon.com

## TOPCON CANADA INC.

110 Provencher Avenue, Boisbriand, QC J7G 1N1 CANADA Phone: 450-430-7771 Fax: 450-430-6457 www.topcon.ca

## TOPCON EUROPE B.V.

(European Representative)

Essebaan 11, 2908 LJ Capelle a/d IJssel, THE NETHERLANDS Phone: 010-4585077 Fax: 010-4585045 www.topconeurope.com  
ITALY OFFICE: Via Monfalcone 39, 20092 Cinisello B. mo (MI) ITALY Phone: 02-61-25-583 Fax: 02-61-25-927

## TOPCON DEUTSCHLAND G.m.b.H.

Giesslerallee 31-33 D-47877 Willich GERMANY Phone: 02154-8850 Fax: 02154-885111 www.topcon.de Med@topcon.de

## TOPCON ESPAÑA S.A.

HEAD OFFICE: Frederic Mompou 5, ED. Euro 3, 08960, Sant Just Desvern Barcelona, SPAIN Phone: 93-4734057 Fax: 93-4733932 www.topconesp.com  
MADRID OFFICE: Avenida Burgos, 16E, 1 ° 28036, Madrid, SPAIN Phone: 91-302-4129 Fax: 91-383-3890

## TOPCON S.A.R.L.

89, rue de Paris 92585 Clichy, Cedex, FRANCE Phone: 01-4106-9494 Fax: 01-4739-0251

## TOPCON SCANDINAVIA A.B.

Neogatan 2 S-43151 Molndal, SWEDEN Phone: 031-7109200 Fax: 031-7109249 info@topcon.se

## TOPCON ( GREAT BRITAIN ) LTD.

Topcon House, Kennet Side, Bone Lane, Newbury, Berkshire RG14 5PX United Kingdom Phone: 01635-551120 Fax: 01635-551170

## TOPCON SOUTH ASIA PTE.LTD.

Blk 192 Pandan Loop, #07-01 Pantech Industrial Complex, SINGAPORE 128381 Phone: 62780222 Fax: 62733540 www.topcon.com.sg

## TOPCON INSTRUMENTS ( MALAYSIA ) SDN.BHD.

Excelsa Business Park Block C, 1st Floor, Jalan Ampang Putra, Taman Ampang Hillir, 55100 Kuala Lumpur, MALAYSIA Phone: 03-42701192 Fax: 03-42704508

## TOPCON INSTRUMENTS ( THAILAND ) CO.,LTD.

77/162 Sinn Sathorn Tower, 37th Fl., Krungthongburi Rd., Klontongsaï, Klongsarn, Bangkok 10600, THAILAND Phone: 440-1152~7 Fax: 440-1158

## TOPCON AUSTRALIA PTY.LTD.

408 Victoria Road, Gladesville, NSW 2111, AUSTRALIA Phone: 02-9817-4666 Fax: 02-9817-4654 www.topcon.com.au

## TOPCON KOREA CORPORATION

2F Yooseoung Bldg., 1595-3, Seocho-Dong, Seocho-Gu, Seoul, 137-876 KOREA Phone: 02-2055-0321 Fax: 02-2055-0319 www.topcon.co.kr

## TOPCON OPTICAL ( H.K. ) LTD.

2/F., Meeco Industrial Bldg., No.53-55 Au Pui Wan Street, Fo Tan Road, Shatin, N.T., Hong Kong Phone: 2690-1328 Fax: 2690-2221 E-mail: sales@topcon.com.hk

## TOPCON CORPORATION BEIJING OFFICE

Room No.962 Poly Plaza Building, 14 Dongzhimen Nandajie Dongcheng District, Beijing, 100027, CHINA Phone: 10-6501-4191~2 Fax: 10-6501-4190

## TOPCON CORPORATION BEIRUT OFFICE

P.O.Box 70-1002 Antelias, BEIRUT-LEBANON Phone: 961-4-523525/523526 Fax: 961-4-521119

## TOPCON CORPORATION DUBAI OFFICE

C/O Atlas Medical FZCO., P.O.Box 54304 C-25, Dubai Airport Free Zone, UAE Phone: 971-4-2995900 Fax: 971-4-2995901

---

# TOPCON CORPORATION

75-1 Hasunuma-cho, Itabashi-ku, Tokyo, 174-8580 Japan.  
Phone: 3-3558-2520 Fax: 3-3960-4214 www.topcon.co.jp

INTRODUCTION .....	1
DISPLAYS FOR SAFE USE .....	4
SAFETY PRECAUTIONS .....	5
MAINTENANCE .....	7
USER MAINTENANCE .....	7
ESCAPE CLAUSE .....	7
WARNING INDICATIONS AND POSITIONS .....	8

## **CONFIGURATION**

NAMES OF MAIN BODY COMPONENTS .....	11
STANDARD ACCESSORIES .....	12

## **COMPONENTS**

COMPONENTS .....	14
------------------	----

## **ASSEMBLY PROCEDURE**

SECURING THE INSTRUMENT TYPE TABLE TOP .....	15
SECURING THE UNIT TYPE TABLE TOP .....	16
SECURING THE PATIENT GRIP PG-1 (OPTIONAL ACCESSORY) .....	16
SECURING THE CHINREST BASE PLATE .....	17
SECURING THE BASE UNIT AND RAIL COVER .....	17
SECURING THE BINOCULAR TUBES .....	18
SECURING THE ILLUMINATION UNIT .....	18
CONNECTING AND SECURING CABLES .....	20
FITTING THE CHINREST TISSUE .....	20
FITTING THE CAP .....	21
SECURING THE TONOMETER MOUNT (OPTIONAL ACCESSORY) .....	21
COUNTER-BALANCING THE VERTICAL MOVEMENT .....	23

## **PREPARATIONS**

POWERING ON .....	25
ADJUSTING THE DIOPTER AND PUPILLARY DISTANCE (PD) .....	25

## **OPERATION PROCEDURES**

FIXING THE PATIENT'S FACE AND FIXATION .....	28
OPERATING THE MICROSCOPE UNIT .....	28
OPERATING THE BASE AND FOCUSING .....	29
OPERATING THE ILLUMINATION UNIT .....	30
ENDING PROCEDURE .....	32

## **MAINTENANCE AND CHECKS**

PERIODIC MAINTENANCE .....	33
DAILY MAINTENANCE .....	33
ORDERING CONSUMABLES .....	33
REPLACING ILLUMINATION LAMPS .....	34
REPLACING FUSES .....	36
RESTOCKING CHINREST TISSUE .....	36
MAINTENANCE PROCEDURE .....	37
CLEANING REMOVABLE PARTS .....	37
CLEANING LENSES AND PRISMS .....	37
CLEANING THE SLIDING PLATE, RAIL AND WHEEL SHAFT .....	38

DISPOSING OF THE PRODUCT .....	38
--------------------------------	----

## **TROUBLESHOOTING**

TROUBLESHOOTING GUIDE .....	39
-----------------------------	----

## **OPTIONAL ACCESSORIES**

DIGITAL CAMERA UNIT DC-1 .....	40
STILL CAMERA ATTACHMENT SR-53 .....	40
BEAM SPLITTER .....	41
TV RELAY LENS .....	41
TV RELAY LENS TL-54 .....	42
TV RELAY LENS TL-55 .....	42
TV ATTACHMENT TL-56 .....	42
TV ATTACHMENT TL-57 .....	43
BACKGROUND ILLUMINATION BG2-GN .....	43
OBSERVATION TUBE .....	43
FIXATION TARGET .....	43
12.5X MEASURING EYEPIECE .....	44
20X EYEPIECE .....	44
APPLANATION TONOMETER .....	44
HRUBY LENS .....	44
PARALLEL BINOCULAR TUBE PB-2 .....	45
YELLOW FILTER UNIT .....	45
AUXILIARY SPRING SO-AS 0, 1, 2, 3 .....	45
PATIENT GRIP PG-1 .....	45
ADAPT COVER SO-AC3, 4, 5 .....	45

## **SPECIFICATIONS AND PERFORMANCE**

SPECIFICATION AND PERFORMANCE .....	46
ELECTROMAGNETIC COMPATIBILITY .....	47
ELECTRIC RATING .....	47
SYSTEM CLASSIFICATION .....	47
PURPOSES OF USE .....	47
OPERATION PRINCIPLES .....	47
SYSTEM CONFIGURATION .....	48
SHAPE OF PLUG .....	49
SYMBOL .....	49